

**LAKWOOD INSTRUMENTS  
MODEL 2350e**

**MICROPROCESSOR-BASED  
pH CONTROLLER**

**INSTALLATION & OPERATION MANUAL**

SERIAL #: \_\_\_\_\_



**Lakewood Instruments**

*7838 North Faulkner Road, Milwaukee, Wisconsin 53224 USA*

*Phone (800) 228-0839 • Fax (414) 355-3508*

*<http://www.lakewoodinstruments.com>*



# Lakewood Instruments™ Model 2350e Controller

## Quick Installation Sheet

1. Attach the four (4) supplied mounting feet to the back of the controller enclosure either vertically or horizontally. Install the controller on a flat, non-vibrating surface. Do not mount the controller to a steel object that has a large temperature change (side of cooling tower, etc). This can cause water to condense inside the enclosure.
2. Install water meters, chemical pumps, plumbing assemblies and the pH sensor (see drawing on back for cooling tower).
3. Install the provided strain reliefs with nuts, if necessary, by removing the attached black plugs and inserting strain relief through hole. Wire the flow switch, pH sensor, water meters and 4-20 mA output; if applicable (see drawing on back). Ensure wiring connections are correct or damage may occur.
4. If doing a conduit installation, remove receptacles and wire pumps and bleed valve directly to the terminals. If using a motorized ball valve, wire as per wiring instructions. Refer to the instruction manual for more details.
5. Plug in chemical pumps and valves to controller (unless hardwired as per step #4).
6. Apply power to the model 2350e controller, press "**CLR**" twice, press "**7**" System setup, press "**2**" Initialization, press "**2**" Whole controller, press "**1**" Yes. After initialization, press the "**CLR**" key several times until you get to the main menu.
7. Press "**1**" Process, Press "**ENT**". This screen allows manual control of the relay outputs to test the chemical pumps and valves. Press "**CLR**" to return to the Process screen.
8. To calibrate the pH take a sample with a handheld pH meter, press the "**PRO**" button, select either ZERO or SPAN and type in the pH value, press "**ENT**". See instruction manual for more details.
9. Program the model 2350e relays for chemical feed schemes. See instruction manual for more details.

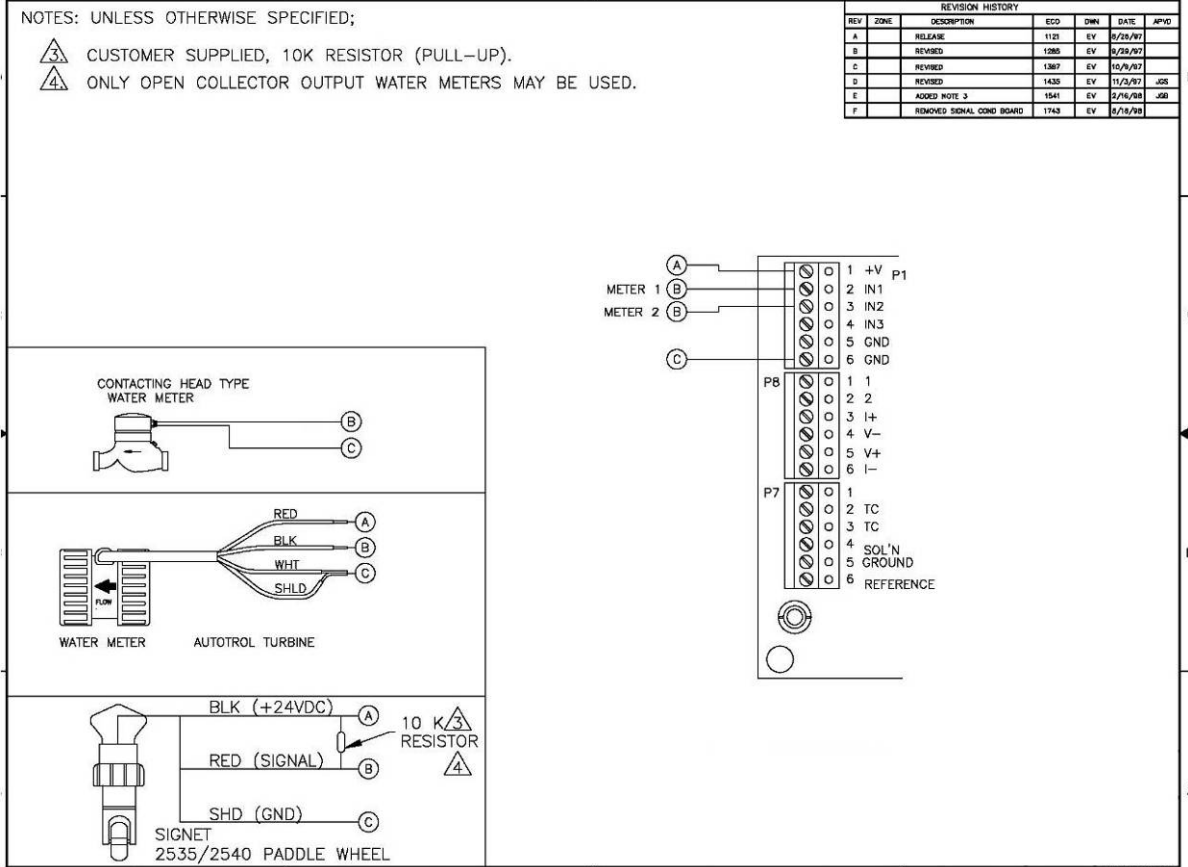
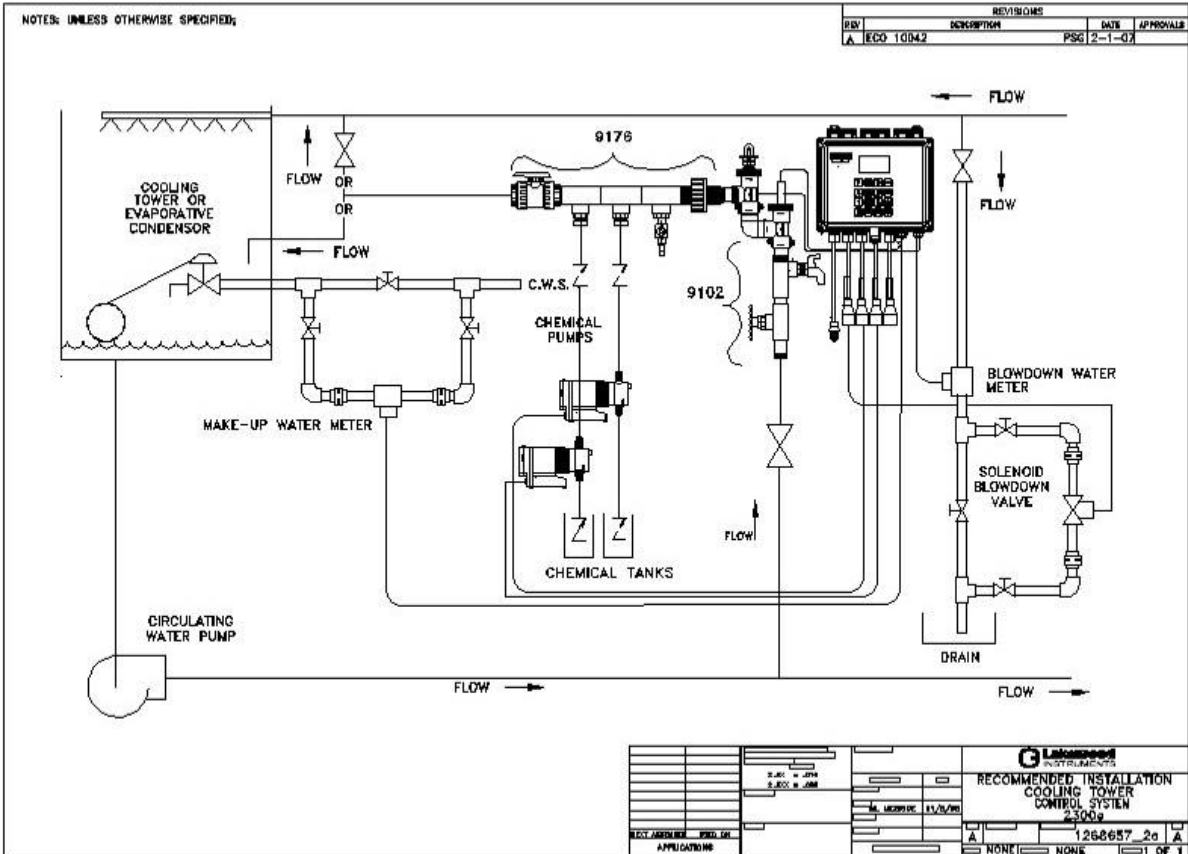

FIGURE A

# **IMPORTANT NOTICE**

## **WARNING: CHEMICAL FEED**

All electromechanical devices are subject to failure from a variety of causes. These include mechanical stress, component degradation, electromagnetic fields, mishandling, improper setup, physical abuse, chemical abuse, improper installation, improper power feeds, and exposure.

While every precaution is taken to insure proper functioning, extra precautions should be taken to limit the ability of over-feeding by limiting chemical quantities available, secondary shut-downs, alarms, and redundancy or other available methods.

## **CAUTION: POWER SOURCE AND WIRING**

Low voltage wiring and high voltage (110 plus) should not be run in the same conduit. Always run separately. Even shielded low voltage is not a guarantee of isolation.

Every precaution should be taken to insure proper grounding and elimination of shorting or Electromagnetic field (EMF) interference.

## **WARNING: ELECTRICAL SHOCK**

To reduce the risk of electrical shock, this equipment has a grounding-type plug that has a third (grounding) pin. This plug will only fit into a grounding-type outlet. If the plug does not fit into the outlet, contact a qualified electrician to install the proper outlet. **DO NOT** change the plug in any way.



## Lakewood Instruments

We thank you for your selection and purchase of a Lakewood Instruments product.

With proper care and maintenance, this device should give you many years of trouble-free service. Please take the time to read and understand this Installation and Operation Manual, paying special attention to the sections on **OPERATION** and **MAINTENANCE**.

If, in the future, any parts or repairs are required, we strongly recommend that only original replacement parts be used. Our Customer Service Department is happy to assist you with your parts or service requests.

 **Lakewood Instruments Customer Service and Technical Support Departments can be reached by calling (800) 228-0839 or faxing (414) 355-3508, Monday through Friday, 7:30 a.m. - 5:00 p.m. CST.**

 **Mail should be sent to:**

**Lakewood Instruments  
7838 North Faulkner Road  
Milwaukee, WI 53224 USA**





# MODEL 2350e

---

## Table of Contents

1.0 Introduction .....	8
2.0 Features, Benefits and Specifications .....	9
2.1 Features .....	10
2.2 Benefits .....	10
2.3 Specifications .....	11
2.4 Ordering Information.....	12
3.0 Unpacking, Mounting and Installation .....	13
3.1 Unpacking .....	13
3.2 Mounting the Enclosure.....	13
3.3 Plumbing Installation .....	14
3.4 Electrical Installation .....	15
3.4.1 Incoming power 115/230 VAC .....	15
3.4.2 Relay Outputs .....	16
3.4.3 Flow Switch Wiring .....	16
3.4.4 Water Meter Wiring.....	17
3.4.5 4-20 mA Output Wiring .....	17
3.4.6 Node Wiring.....	17
4.0 Functional Overview.....	18
4.1 Display.....	18
4.2 Keypad .....	18
4.3 Menu .....	18
4.4 Security Levels .....	19
5.0 Starting Up the Controller.....	19
6.0 Operation of Controller .....	20
6.1 Process Screen .....	20
6.2 Manual Operation of the Relays .....	21
6.3 Calibration of PH .....	21
6.3.1 Calibration .....	21
6.3.2 Zero or Span? .....	22
6.3.3 Calibration Error Messages .....	22
6.3.4 Calibration Check in Buffer Solutions .....	22
6.4 Main Menu.....	23
6.5 Configuring the Relays .....	24
6.5.1 Configuring Relays 1,2,3,4 .....	24
6.5.1.1 Disabled .....	24
6.5.1.2 By Setpoint.....	25
6.5.1.2.1 Setpoint .....	25
6.5.1.2.2 Deadband.....	25
6.5.1.2.3 Overfeed Time.....	26
6.5.1.2.4 When to Activate .....	26

6.5.1.3	By Water Meter .....	26
6.5.1.4	By Percent of Time.....	27
6.5.1.5	By Feed Schedule.....	28
6.5.1.6	As an Alarm Relay .....	28
6.5.1.7	Change My Name .....	29
6.5.1.8	Scheduled Lockout?.....	29
6.5.2	Setting Up the Feed Schedule .....	30
6.5.3	Alarms .....	32
6.5.4	Water Meters .....	32
6.5.5	4-20 mA Outputs.....	34
6.5.5.1	Setup of the 4-20 mA Output .....	34
6.5.5.1.1	Set the 4-20 mA Range.....	35
6.5.5.1.2	Calibrate.....	35
6.5.5.1.3	Which Process? .....	35
6.5.5.1.4	Manual Control.....	35
6.5.5.1.5	Change My Name .....	35
6.5.6	The System Setup Menu .....	36
6.5.6.1	Process Parameters.....	36
6.5.6.1.1	Change My Name .....	36
6.5.6.1.2	Temperature Compensation.....	36
6.5.6.1.3	pH Per °C .....	37
6.5.6.1.4	Damping.....	37
6.5.6.2	Initialization .....	37
6.5.6.3	Digital Inputs .....	38
6.5.6.4	Firmware Versions .....	38
6.5.6.5	Change the Security Passwords .....	38
6.5.6.6	Diagnostics .....	38
6.5.6.7	Communications .....	39
6.5.6.7.1	Com Port Setup.....	39
6.5.6.7.2	Initialize Modem .....	40
6.5.6.7.3	Remote Password .....	40
6.5.6.8	Node Installation .....	40
6.5.7	Setting the Clock.....	41
6.5.8	Changing the Security Levels .....	41
7.0	Maintenance.....	42
7.1	Sensor Maintenance.....	42
7.2	Flow Switch Maintenance.....	43
7.2.1	Replacing The Reed Switch.....	44
7.3	Replacing the Fuse.....	44
8.0	Troubleshooting .....	45
8.1	Error Messages .....	45
9.0	Factory Service .....	47

## 10.0 Drawings

10.1 Cooling tower Suggested installation .....	1268657-2a
10.2 Wiring Diagram, Sensor Wiring .....	1268659-2a
10.3 Wiring diagram for water meter inputs .....	1104607
10.4 Electrical Schematic .....	1268647-1a
10.5 Electrical Schematic .....	1268647-2a
10.6 Wiring Diagram RS2L Option .....	1169899
10.7 Wiring Diagram RS2L Option .....	1169900
10.8 Wiring Diagram 4-20 mA output, 35L .....	69954
10.9 Wiring Diagram NIN Option.....	04263

## 1.0 Introduction

The Model 2350e is a LONWORKS Technology, microprocessor based, menu driven, pH water treatment controller designed for use in cooling towers. The Model 2350e provides for pH tracking and control, flow monitoring and chemical injection. The Model 2350e is CSA and ANSI/UL approved.

The Model 2350e uses the latest in microprocessor capability, giving the user a high level of application flexibility. A large illuminated graphics screen, multiple inputs, and an intuitive menu characterize this new technology.

Security features allow full access to programming features or restrict access to viewing only. An operator password can help ensure that only authorized personnel will operate the system.

The Model 2350e is user-friendly with a graphical screen and 16-key numeric keypad. It accepts multiple inputs and is easily configured. This controller can easily be upgraded in the field. It's a combination of reliability, accuracy, security and simplicity.

LONWORKS Technology gives you a high level of flexibility with the capability of adding nodes, additional inputs and outputs, for monitoring and control. These nodes have functions such as extra relay outputs, drum level inputs, pH inputs, conductivity inputs, ORP inputs, 4-20 mA inputs and water meter inputs.

Nodes are added, using the –NIN option, according to a mapped network. The mapped network shows the full node addition capability of the LonWorks based 2000 series controllers.

The mapped network for the model 2350e shows that any or all of the following nodes can be added; two relay nodes, two 4-20 mA input nodes, two digital input nodes, four remote sensor nodes (any combination of pH, conductivity, or ORP), and one other conductivity node.

The complete mapped network is shown below.

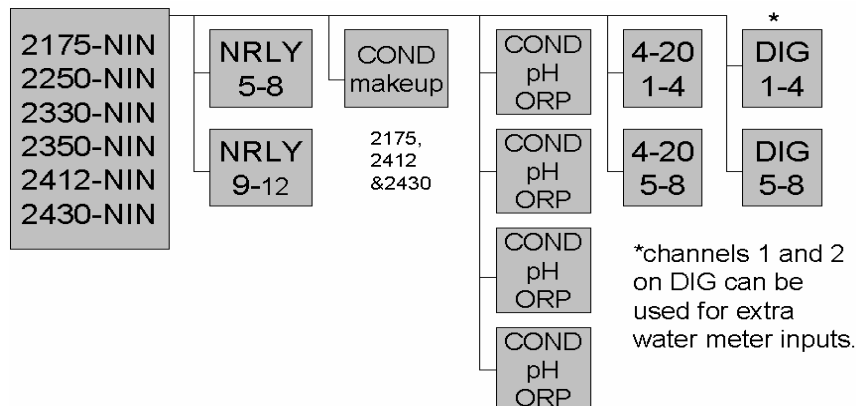

## 2.0 Features, Benefits, Specifications

---



### LOCK SCREWS

The lock screws keep your circuit boards secure and provide easy access for wiring and setup. Simply turn the lock screw and pull open the front panel.

### 16-BUTTON KEYPAD

**ENT** = for Menu selection and/or acceptance of selected values.

**CLR** = to exit a Menu selection and/or skip input options.

**DSP** = to change languages.

**PRO** = to program a Menu selection.

### ENCLOSURE

A sturdy NEMA 4X rated enclosure protects your controller. Make sure it is properly mounted (SEE: **INSTALLATION; Mounting**). The power cord and receptacles can be removed so that the controller can be hardwired through 1/2" conduit knockouts.

Figure 1: **Model 2350e**

## 2.1 FEATURES

---

- pH input with pH sensor diagnostics indicates fouled reference or broken glass.
- Integral flow sight & flowswitch lockout.
- Two (2) water meter inputs. Records both makeup (**MTR1**) and Blowdown (**MTR2**) water meter total gallons.
- Configure Blowdown water meter (**MTR2**) as second makeup meter.
- Four user configurable relays for pH control and chemical addition. These relays can be configured in multiple ways including scheduled feed for biocide addition
- User-selectable relay options:
  - Feed by setpoint, direct or reverse
  - Water meter actuated feed. **MTR1**, **MTR2** or the sum of the two
  - Percent of Time feed
  - Feed Schedule timer
  - General alarm
- Three security levels: View only, operator, technician
- 4-20 mA output available as an option.
- Remote communications available as an option.
- 16-key numeric keypad and illuminated graphical display allow for quick and easy programming.
- The Model 2350e controller stores all setpoints, calibration values, and relay configurations in an EEPROM. An EEPROM does not require a battery to retain information, so if power is lost these values will be retained for years. The 2350e includes a battery backup device to retain information such as water meter totals, and clock and calendar information. Battery life is approximately 3 months if no power is applied to the controller.

## 2.2 BENEFITS

---

- Multiple control options in a single economical package.
- Very accurate control of chemical feed.
- Very low maintenance.
- Tolerant to power surges and brownouts.
- Power cord, plug outlets and attached plumbing make installation easy. There is plenty of protected room inside the enclosure for electrician wiring.
- Very accurate monitoring of the evaporated water.
- Has expansion slots to add additional control, such as additional relay outputs, 4-20 mA outputs, remote sensor inputs, digital inputs, and 4-20 mA inputs.

## 2.3 Specifications

---

**pH range**

0-14 pH

**pH Accuracy**

±0.05 pH

**pH Resolution**

0.01 pH

**Accuracy & Repeatability**

± 1.0% of scale

**Deadband/Setpoint**

User programmable

**Auto/Manual outputs**

Menu selectable

**Keypad**

16 - key push buttons

**Display**

Illuminated 128 x 64  
pixel LCD

**Water meter inputs (2)**

Contact head, paddle wheel or turbine

**Timer**

Relay run time exceeded.

**Output relays**

4 selectable use

**Relay ratings**

3A each, 10A total

**Power**

120/240 VAC 50/60 Hz 6W

**Ambiant temp**

32° - 158°F (0 - 70°C)

**Storage temp**

32° - 158°F (0 - 70°C)

**Max. Water temperature**

140°F

**Max. water pressure**

140 psi @ 100°F

**Languages**

Selectable:

English, plus one of:

Spanish

German

French

**Enclosure**

NEMA 4X

## 2.4 Ordering Information

---

2350e LONWORKS Technology-based pH controller with 4 selectable relays for HIGH/LOW setpoints or alarms. Includes plumbing, sensor, flowswitch, power cord and outlets. pH range is 0-14 pH with adjustable deadband.

### CONTROLLER OPTIONS

-35L Two 4-20 mA outputs configurable for remote data acquisition of pH  
-RS2L Communications node with shareware software  
-NIN Network interface node. Allows 2 **NRLY**, 1 **Makeup NCON**, 4 sensor nodes (**NpH or NCON**), 2 **N420I** and/or 2 **NDIG** to be added.

### LANGUAGE OPTIONS (optional, choose one, English and Spanish Standard)

-EF English and French.  
-EG English and German.

### REMOTE NODE OPTIONS (optional, MUST purchase -NIN Option)

NRLY Four additional relays with enclosure (2 per 2000 Series Controller).  
NpH pH/ORP node for a pH or ORP sensor.  
N420I 4-20 ma input node for up to 4 4-20 ma inputs.  
NDIG Digital input node for up to 4 digital inputs.  
NCON Conductivity node for makeup water or closed loop control (node only).  
NCKT Conductivity node for makeup water or closed loop control with PVC sensor, tee and enclosure. Maximum water pressure is 140 psi @ 100 °F. Maximum temperature is 140°F.

***NOTE: NOT FOR USE WITH MULTIPLE COOLING TOWERS.***

### MOUNTING OPTION

MP Mounting Plate

### SOFTWARE AND EXTERNAL MODEMS

LRWS *Windows*-based software for computer to communicate with 2000 Series Controllers  
MD4X High-Baud modem in NEMA 4X enclosure ready to power  
MD High-Baud modem for use with 2000 Series Controllers



## 3.0 Unpacking, Mounting and Installation

---

### 3.1 Unpacking

---

Inspect the shipping carton for obvious external damage. Note on the carrier's bill-of-lading the extent of the damage, if any, and **notify the carrier**. Save the shipping carton until your Model 2350e controller is started up.

**☎ If shipping damage has occurred, call the Lakewood Instruments Customer Service Department at (800) 228-0839 and return the controller to the factory in the original carton.**

### 3.2 Mounting the Enclosure

---

The Model 2350e is supplied with four mounting feet. The Model 2350e can be mounted to a panel or to a flat non-vibrating wall.

- Attach the four mounting feet to the back of the controller enclosure.
- Install on smooth surface to prevent stress on the mounting feet.
- Do not install on vibrating wall.
- If enclosure is installed in corrosive environments, consider purging.
- Dimensions indicated as inches (millimeters).
- The enclosure material is PVC.
- Use #10 mounting screws (4).
- Avoid drilling or punching additional holes in the controller enclosure. Damage incurred as a result of any alteration to the enclosure is not covered under the Lakewood Instruments product warranty.

The dimensions of the enclosure in inches are:

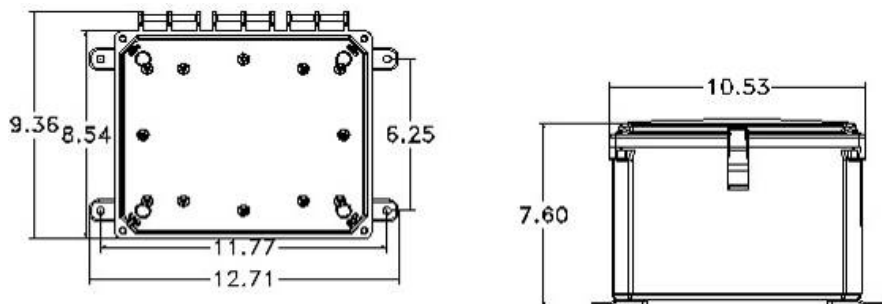

The model 2350e has a shipping weight of about 8 lbs.

**NOTE: EXCESSIVE HEAT AND/OR DIRECT SUNLIGHT EXPOSURE WILL DARKEN THE LCD DISPLAY SCREEN, MAKING IT DIFFICULT TO READ, AND MAY SHORTEN THE LIFE OF OTHER ELECTRONIC COMPONENTS.**

### 3.3 Plumbing Installation

---

#### PLUMBING MATERIALS

- Inlet plumbing can be ¾ inch (1.9 cm) PVC, CPVC, or iron pipe.
- Provide at least 1 gpm (3.79 Lpm) to the sensor. A 4-psi (0.3 bar) differential pressure from take-off to injection is sufficient. If flow is marginal, consult your Lakewood Instruments Factory Representative. The maximum recommended flow is 5 gpm (18.93Lpm).
- Outlet plumbing can be ¾ inch (1.9 cm) PVC, CPVC, or iron pipe. PVC, CPVC Schedule 80 is recommended for strength and sunlight protection.
- If iron pipe is used, install a PVC union to relieve the stress on the plumbing.
- Install the reed switch into the flow switch plumbing assembly before mounting plumbing assembly.
- The sample line inlet should be plumbed vertically downstream of the recirculation pump and upstream of the heat exchanger with flow in the upward direction. This line brings the sample water into the sensor plumbing for conductivity measurement. If the Lakewood Instruments flow switch plumbing assembly is used, this flow of water also pushes the flow switch float up to activate the relay outputs of the controller.

***NOTE: FOR YOUR CONVENIENCE, INCLUDE A LAKEWOOD INSTRUMENTS MODEL 9102 SAMPLE LINE SHUT-OFF VALVE AND A SAMPLE VALVE SPOUT (AS SHOWN) IN THE INLET FLOW PLUMBING.***

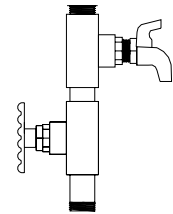

**Figure 2:  
Model 9102 Valve & Spout**

- The sample line outlet flow (solution/sample line) should be plumbed to the tower return line or the tower basin, where you can insert your chemical feed system. Refer to the suggested installation drawing in the back of this manual for an example of a typical installation.
- Remember to install isolation and bypass valves so that maintenance can be performed.

***WARNING: NEVER INJECT CHEMICALS UPSTREAM OF THE CONTROLLER FLOW CELLS!***



If you have questions or need assistance, call Lakewood Instruments Technical Service Department at (800) 228-0839, Monday-Friday, 7:30 a.m. - 5:00 p.m. CST.

**WARNING: SOME CHEMICALS MAY HAVE TO BE INJECTED DIRECTLY INTO THE COOLING SYSTEM WATER LINE AND NOT INTO THE SAMPLE LINE. CONTACT YOUR WATER TREATMENT SPECIALIST FOR SPECIFIC RECOMMENDATIONS.**

**NOTE: IF THE SOLUTION/SAMPLE LINE IS RETURNED TO THE COOLING TOWER RETURN LINE, USE A CORPORATION STOP (LAKEWOOD INSTRUMENTS MODEL 9160), A SOLUTION LINE INJECTOR OR A DISPERSING PIPE . THIS AIDS CHEMICAL-WATER MIXING AND ENHANCES WATER TREATMENT CONTROL CAPABILITIES.**

## 3.4 Electrical Installation

---

### 3.4.1 Incoming Power 115/230 VAC

---

The Model 2350e can be powered from either 115 VAC or 230 VAC at 50/60 Hz. The Model 2350e controller comes with a power cord and receptacles. The power cord and receptacles are rated for 115VAC. If the controller will be powered by 230 VAC, the power cord and receptacles will need to be removed and the incoming power and the relay outputs will need to be hard-wired.

The incoming power is connected to terminal block TA at the bottom right corner of the power supply board. There is a hot or line input (terminal 4), a neutral input (terminals 2 and 3) and an earth ground input (terminal 1). The hot is wired to the fuse holder located on the bottom of the enclosure. The neutrals are wired directly to terminals 2 and 3 of terminal block TA. Refer to the drawing in the back of this manual for wiring instructions.

### 3.4.2 Relay Outputs

---

The relay outputs are of the same voltage as the power input. Ensure that the devices that are to be connected to the relay outputs are of the same voltage rating or damage will occur.

The relay outputs are wired to the receptacles. The receptacle on the far left is relay #1 and the receptacle on the far right is relay #4. On the power supply board, relay #4 is on the far left and relay #1 is on the far right. If 115 VAC is used simply plug your devices into the molded receptacles. If 230 VAC is used, remove the receptacles and hard-wire your devices to the relay outputs.

Relay #1 and #2 have both a normally open and normally closed contact. This is designed for use with motorized valves. The normally open (NO) contact is connected to the open connection of the valve and the normally closed (NC) contact is connected to the close connection of the valve. The other two relays only have a normally open contact. Each relay output requires a neutral connection and an earth ground connection for proper operation.

Refer to the drawing in the back of this manual for wiring instructions.

<p><b>WARNING! <u>DO NOT</u> PLUG IN CHEMICAL PUMPS THAT ARE LARGER THAN 1/6 HORSEPOWER. THE CONTROL RELAYS ARE INTENDED FOR ELECTRONIC OR SMALL MOTOR-DRIVEN CHEMICAL PUMPS. LARGER PUMPS REQUIRE THE -HR OPTION WITH 25-AMP-RATED INTERPOSING RELAYS. CONTACT LAKEWOOD INSTRUMENTS FOR SPECIAL INSTRUCTIONS.</b></p>
--

### 3.4.3 Flow Switch Wiring

---

The model 2350e has a flow switch input. The purpose of the flow switch input is to disable the relay outputs on a loss of flow in the system. The flow switch input requires a digital contact. Any digital contact rated for 24 VDC and 500 mA may be used, such as a relay driven by the recirculation pump. Lakewood Instruments manufactures a flow switch plumbing assembly for use with the model 2350e.

If a flow switch is not used then a jumper must be installed across the flow switch connections. Refer to the drawings in the back of this manual for wiring instructions.

### **3.4.4 Water Meters**

---

The Model 2350e will accept two water meter inputs. These inputs can be configured for make-up, make-up Second Source, Bleed, or Chill Loop make-up. Refer to the water meter manufacturer's manual for plumbing information.

The 2350e series controllers will work directly with the following types of meters: dry contacting head meters, Seametrics open collector output meters, Signet 2535 and 2540 paddle wheel meters, and the Autotrol 1 inch and 2 inch meters. Contact Lakewood Instruments for other types of water meters. The water meters are wired to terminal block P1 which is the top terminal block on the I/O board.

Refer to the drawing in the back of this manual for wiring instructions.

### **3.4.5 4-20 mA Output Wiring**

---

If the -35L option is ordered, the model 2350e has two channels of 4-20 mA output. This output can be isolated (externally powered) or non-isolated (internally powered). The 4-20 mA outputs are wired directly to the -35L option card.

Refer to the drawing in the back of this manual for wiring instructions.

### **3.4.6 Node Wiring**

---

If the -NIN option is ordered with any external nodes (NpH, NCON, NRLY, NDIG, or N420I) they must be wired to the controller before installation and programming can take place. Nodes require +24 VDC for operation and twisted pair wire for data transmission. The NIN option card can provide the +24 VDC for up to two nodes using non-twisted pair wire. If using three or more nodes an external +24 VDC power supply run in parallel is recommended.

Recommended twisted pair for data specifications are:

Beldon 85102, single twisted pair, stranded 9/29, unshielded, plenum.

Beldon 8471, single twisted pair, stranded 9/29, unshielded, nonplenum.

JY (ST) Y 2 X 2 X .8, UL Level IV 22 AWG, twisted pair, typically solid and unshielded.

Four wire helical twist, solid, shielded.

If shielded cable is used, the shield should be connected to earth ground via a 470K ohm, .25 watt, metal film resistor to prevent static charge buildup.

Nodes are wired directly to the NIN card inside the controller enclosure.

Please refer to the diagram in the back of this manual for wiring instructions.

## 4.0 Functional Overview

### 4.1 Display

The model 2350e uses an illuminated 128x64-pixel LCD digital display for ease of viewing. It has multiple lines to display information such as the pH reading, alarms, relay status, relay configuration, clock, flow totals for both water meters, and menu selections.

### 4.2 Keypad

The model 2350e uses a 16-key numeric keypad for ease of programming. The keys have the following functions:

ENT	To accept a setting or to enter a screen.
CLR	To exit a screen or to access the main menu.
PRO	To calibrate the controller.
DSP	To change languages.
UP arrow	To move about in the menu.
DOWN arrow	To move about in a menu.
Number keys	To input a value or to select a menu item.

### 4.3 Menu

The model 2350e is programmed and calibrated by the use of a menu. The complete **Main Menu** has 8 available options that can be accessed in the **Technician Level**. However, a list of only six options can be viewed at one time. Use the **↑** and **↓** keys to scroll through the options. As an introduction, here is a graphic overview of the first level of each option in the **Main Menu** to see how it operates. Complete details of each option are provided later in this manual.

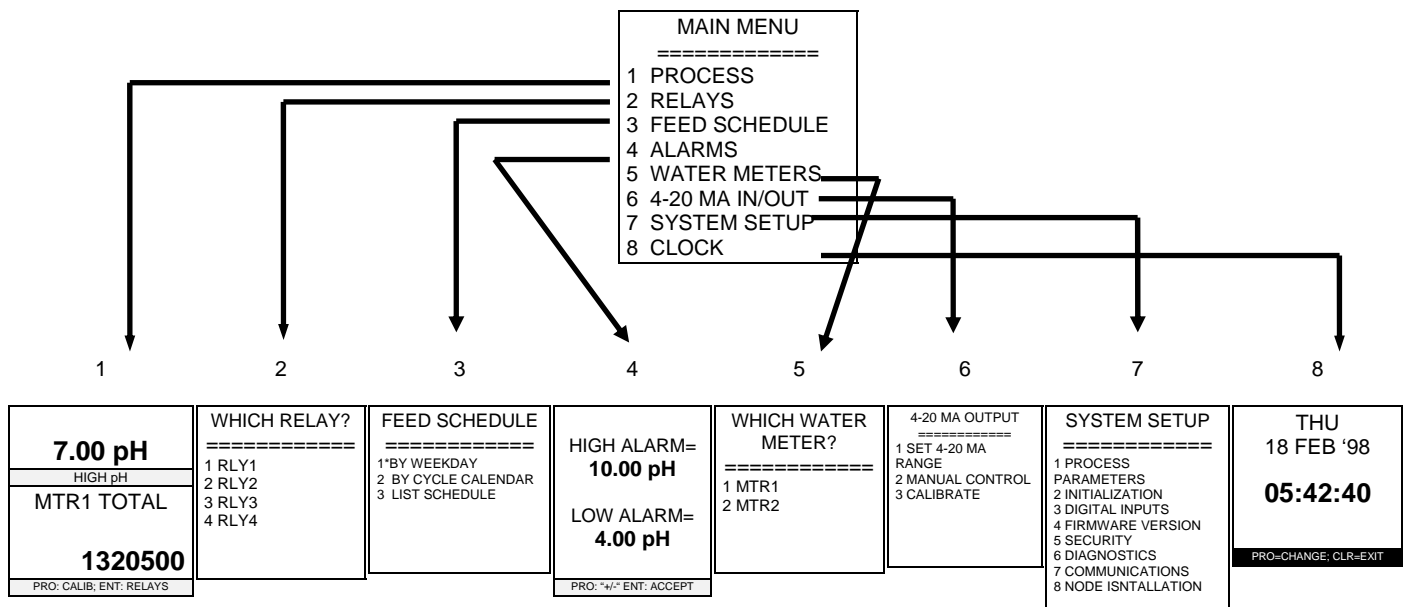

## 4.4 Security Levels

---

The model 2350e has a security levels to prevent tampering of the controller. The Model 2350e offers three (3) security levels: 1) **View Only**, 2) **Operator** and 3) **Technician**. When the controller is in the **View Only** or **Operator** security level, the menu is locked out. In **View Only**, access is limited to manual operation of the relays, and viewing all of the process screens. In the **Operator** mode the user can operate the relays manually, view the process screens, and calibrate the controller. He cannot change any other settings. In the **Technician** mode the operator has full access to all of the menus.

A password is required to change from a tight security level to a less restrictive security level. Each level has its own factory-preset password (2222 for Technician, 1111 for Operator). If the controller is in the **View Only** or **Operator** mode just press the appropriate password on the keypad to change to a less restrictive security mode.

The passwords can be changed to personalized passwords from the **Technician Level Menu**.

***NOTE: IF YOU USE PERSONALIZED PASSWORDS, MAKE SURE THEY ARE RECORDED IN A SAFE AND SECURE PLACE.***

## 5.0 Starting Up the Controller

---

Once the Installation is complete it is time to start up the controller.

Initiate sample flow to the controller by opening the sample line isolation valves. Check for leakage.

Power up the controller by either turning on the circuit breaker or plugging the power cord into a 120 VAC receptacle.

It is best to initialize the whole controller to remove any settings that may be in the memory before programming the controller. Refer to section 6.5.6.2 of this manual to initialize the controller.

If applicable, install each node in software.

Set the clock by following section 6.5.7.

Set the high and low pH alarms by following section 6.5.3.

Configure the relays for operation by following section 6.5.

Calibrate the pH by following section 6.3

Verify operation of the controller before leaving the area.

## 6.0 Operation of the Controller

### 6.1 Process Screen

The screen that is used the most in the 2350e controller is the Process Screen. Below are the process screen views. The process screen has three sections. The top section shows the pH reading. The alarm bar is the middle section and appears between the top and bottom sections. It is solid in appearance and flashes showing the current active alarms in sequence if there are multiple alarms. The bottom section has user selectable readings as shown below.

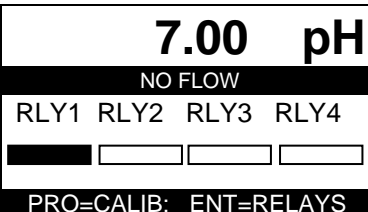
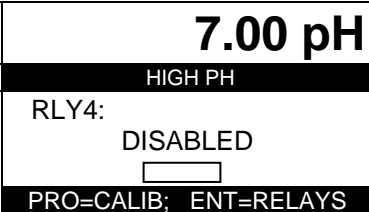
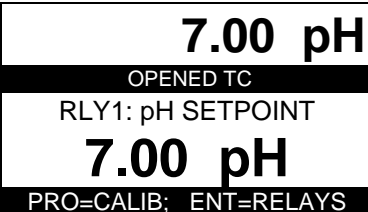
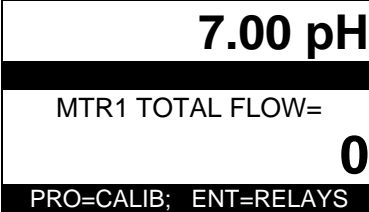
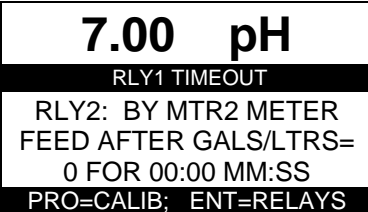
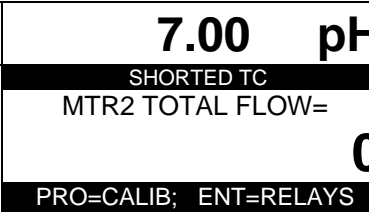
<b>1 - DATE SCREEN</b> 		<ul style="list-style-type: none"> <li>• There are many different screens available in the <b>PROCESS</b> screen. These screens allow you to view the unit's settings (incl. time setting, relay set-ups, total flow, etc.) without the danger of altering them. Access these screens by using the <b>↑</b> and <b>↓</b> keys to scroll through the available screens.</li> <li>• Press <b>"ENT"</b> to manually enable a relay for testing or troubleshooting purposes.</li> <li>• Press <b>"PRO"</b> to calibrate the pH.</li> <li>• Press <b>"CLR"</b> to access the main menu.</li> </ul>	
<b>2 - ALL RELAY SCREEN</b> 	<b>5 - RELAY 1,2,3,4 SETTINGS</b> 		
<b>3 - BLOW SETPOINT SCREEN</b> 	<b>6 - MTR1 TOTAL FLOW</b> 		
<b>4 - RELAY 2 SETTINGS</b> 	<b>7 - MTR2 TOTAL FLOW</b> 		<p>If nodes are installed there will be additional screens for the additional inputs or outputs. Please see your specific node manual for more information.</p>



## 6.2 Manual Operation of the Relays

---

All four of the relays can be operated manually. To manually operate the relays:

Go to the **Process** screen. Press “**ENT**”. You will be taken to a screen that looks like:

AUTO-MANUAL (5 MINS.)	
(1) RLY1	<input checked="" type="checkbox"/>
(2) RLY2	<input type="checkbox"/>
(3) RLY3	<input type="checkbox"/>
(4) RLY4	<input type="checkbox"/>
Press 1-4; CLR=EXIT	

Press “1-4 “ to manually change the state of that particular relay. If the relay is already on, pressing that number will turn it off. A five-minute countdown timer will start. After five minutes has expired the relay will return to automatic control. A relay that is in manual control will stay in manual control until the five minutes expires even if this screen is exited. The five-minute timer helps to prevent damage to the system if a relay is left in manual. **WARNING: Manual control overrides everything including the flow switch input. Use care when operating relays manually with no flow in the system.**

## 6.3 Calibration of PH

---

### 6.3.1 CALIBRATION

---

The model 2350e controller uses a single point calibration. A two point calibration is not necessary if using a Lakewood Instruments pH sensor because all Lakewood pH sensors have a slope of 59 mv per pH. If the slope has changed enough to require a two point calibration then the sensor should be cleaned or replaced.

We recommend that the pH calibrations only be performed with the pH sensor mounted as it will be used in the system. Buffers can be used to check calibrations but should not be used for calibration purposes (see below).

It is necessary to have an accurate reading of the process water to properly calibrate the controller. A hand-held pH meter that tests the sample is best. Once you have obtained a reading, immediately enter the value into the controller. In the process screen, press **PRO**. Select either **ZERO** or **SPAN** (see below). Use the number keys to enter the value, and then press **ENT**. When the number is accepted, you will see the **CALIBRATION COMPLETE** screen before the LCD display switches back to the original **PROCESS** screen. Then take a second sample with a hand-held pH meter and confirm the reading on the display.

### 6.3.2 ZERO or SPAN?

---

The model 2350e controller is capable of performing a two point calibration using both the **ZERO** and **SPAN** calibrations. The operator must pick either **ZERO** or **SPAN** to perform a single point calibration. There are error messages associated with calibration points (see below). If an improper calibration is being performed an error message may appear.

To perform a good single point calibration the **ZERO** calibration should be performed at a lower pH than the **SPAN** calibration. A good rule of thumb is to perform a **ZERO** calibration if the measured pH is less than 7.00 pH and use the **SPAN** if the measured pH is greater than 7.00 pH.

### 6.3.3 CALIBRATION ERROR MESSAGES

---

The model 2350e will display calibration error messages to alert the operator of a possible calibration error. “**THE SPAN AND ZERO VALUES SHOULD BE AT LEAST TWO pH APART**” error message will occur if the zero and/or the span calibrations are performed within two pH of each other. If you receive this error message initialize the calibration and repeat the calibration using the rule of thumb above.

The “**pH DEVIATION GREATER THAN 1.5 FROM DEFAULT CHK PROBE-CABLE-SOL’N**” error message will occur if the calibration value is more than 1.5 pH away from the value the controller thinks the pH should be based on the signal input from the sensor. This could indicate a failed sensor or interference in the system. If you receive this message perform a calibration check using buffer solutions.

### 6.3.4 CALIBRATION CHECK IN BUFFER SOLUTIONS

---

To check the calibration of the sensor in buffer solutions, the sensor and a solution ground wire are necessary. Perform the calibration check as follows:

- Initialize the calibrations.
- Shut the isolation valves to the controller plumbing assembly.
- Open the controller front panel. Disconnect the solution ground wire from terminal 5 of terminal block P7.
- Connect a wire that has been stripped at both ends to terminal 5 of terminal block P7.
- Place the pH sensor and the wire connected in the previous step into the buffer solutions.
- Verify calibrations in at least two buffer solutions at least 2 pH apart.
- Re-install the sensor into the plumbing. Ensure locking ring is locked.
- Remove the stripped wire from terminal block P7 and re-attach the solution ground wire.
- Restore flow to plumbing assembly
- Perform a single point calibration if necessary.

## 6.4 Main Menu

---

The **MAIN MENU** of the 2350e looks like this:

```
          MAIN MENU
          =====
1 PROCESS
2 RELAYS
3 FEED SCHEDULE
4 ALARMS
5 WATER METERS
6 4-20 MA IN/OUT
7 SYSTEM SETUP
8 CLOCK
```

The **MAIN MENU** can be accessed from the **PROCESS** screen by pressing “**CLR**”. If “**CLR**” is pressed and the **MAIN MENU** does not appear, the controller is probably in the **VIEW ONLY** or **OPERATOR** security mode. If the controller is in the **VIEW ONLY** or **OPERATOR** security mode, enter the **TECHNICIAN** security password to be able to access the **MAIN MENU**.

To move about in the menu screen use the **↑** and **↓** keys to highlight the desired option and press “**ENT**” or simply press the number key for the desired option.

Use the “**ENT**” key to accept a setting or to enter a screen. Use the “**CLR**” key to reject a setting or to exit a screen. From anywhere in the menu, pressing “**CLR**” will take you one step closer to the **MAIN MENU**.

Each of the **MAIN MENU** options are discussed in detail later in this manual.

## 6.5 Configuring the Relays

---

To access the relay configuration screen from the **MAIN MENU**, press “2” or highlight **RELAYS** and press “**ENT**”. The following screen will appear.

WHICH RELAY?	
=====	
1	<b>RLY1</b>
2	RLY2
3	RLY3
4	RLY4

Select the relay that you want to program.

### 6.5.1 Configuring Relays 1,2,3,4

---

Below is the **RELAY OPTIONS** screen. The asterisk (\*) next to one of the options tells you how that relay is configured. Relays 1, 2, 3, and 4 can be programmed in each of the methods shown on the **RELAY OPTIONS** screen.

RLY2	
=====	
1*	DISABLED
2	SETPOINT
3	WATER METER
4	PERCENT BLOWDOWN
5	PERCENT OF TIME
6	FEED SCHEDULE
7	ALARM RELAY

#### 6.5.1.1 Disabled

---

Relays 1, 2, 3, and 4 can be disabled. When a relay is disabled, it will not energize automatically.

- From the **RELAY OPTIONS** screen press “1” **Disabled** to disable the relay.

### 6.5.1.2 By Setpoint

---

Relays 1, 2, 3, and 4 can be configured to operate based on a setpoint.

To set up the relay to operate based on a setpoint, select **SETPOINT** in the RELAY OPTIONS screen. The following screen will appear.

SETPOINT <b>7.00 pH</b>
DEADBAND <b>0.00 pH</b>
PRO: +/-      ENT: ACCEPT

#### 6.5.1.2.1 SETPOINT

---

In the **SETPOINT** screen you will set the **SETPOINT**, the **DEADBAND** and the **OVERFEED TIME** alarm.

The **SETPOINT** is the pH value that you are trying to maintain. Check with your water treatment engineer to determine the pH setpoint for your system needs.

Follow these instructions to establish the controller's setpoint:

- Use the keypad numbers to enter the proper pH setpoint and press "**ENT**". When finished, you will automatically be moved down to the deadband.

#### 6.5.1.2.2 DEADBAND

---

After the setpoint is established, the controller's deadband must also be set. "**Deadband**" refers to the amount of pH above and below the setpoint—a range within which the controller will not react. Due to continuous fluctuations in the pH level, it is necessary to have this deadband range or stable readings will be difficult to obtain. The Deadband should be a small percentage of the setpoint. Half the deadband amount will be automatically put above the setpoint, and the other half below it.

For example, a pH setpoint of 8.00 pH with a deadband of 0.2 pH would result in the relay turning on at 8.10pH and turning off at 7.90 pH.

- Use the keypad numbers to enter the proper deadband setpoint and press "**ENT**". When finished, you will automatically be switched to the **OVERFEED TIME** alarm screen.

### 6.5.1.2.3 OVERFEED TIME

---

The **OVERFEED TIME** alarm is designed to notify the operator of a problem in the chemical feed system such as, a pump has lost its prime or there is no chemical in the drum. It will also protect the system from overfeeding chemical when the indicated pH does not display a change in actual pH. The **OVERFEED** timeout function will display a visual alarm on the display and **it will turn off the relay**. If a relay is configured as an alarm relay, the **OVERFEED TIME** alarm will energize the alarm relay. To disable this function set the **OVERFEED** time to 0:00.

- Use the keypad numbers to enter the time in hours and minutes before this alarm will appear and press "**ENT**". Maximum setting is 17 hours and 59 minutes.

### 6.5.1.2.4 WHEN TO ACTIVATE

---

After configuring the SETPOINT, the DEADBAND, and the OVERFEED alarm, the controller will automatically move to the **WHEN TO ACTIVATE** screen. To set up to feed an acid type product set the relay to activate *above* the setpoint. To set up to feed a caustic type product set the relay to activate *below* the setpoint.

WHEN TO ACTIVATE  
=====

1 \*ABOVE SETPOINT  
2 \*BELOW SETPOINT

- In the **WHEN TO ACTIVATE** screen, select either "**1**" **ABOVE SETPOINT** or "**2**" **BELOW SETPOINT**.

### 6.5.1.3 By Water Meter

---

Relays 1, 2, 3, and 4 can be configured to operate for a specified amount of time based on a specified amount of flow through the water meter inputs. **MTR1**, **MTR2** or the sum of **BOTH** water meter inputs can activate the relay.

- From the **RELAY OPTIONS** screen press "**3**" **WATER METER**.
- Select either **MTR1** or **MTR2** or **BOTH** as the trigger for the relay.
- Use the keypad to enter the amount of flow before the relay is activated. Press "**ENT**".
- Enter the amount of time that the relay will be activated. Press "**ENT**".

### 6.5.1.4 By Percent of Time

The Percent of Time feature allows you to feed chemical strictly based by a percent of time. This relay control scheme works in patterns of 20-second time blocks. A relay is on for some multiple of 20 seconds and off for some multiple of 20 seconds. Below is a chart showing how Percent of Time works over a 400 second example.

x = 20 seconds on  
- = 20 seconds off

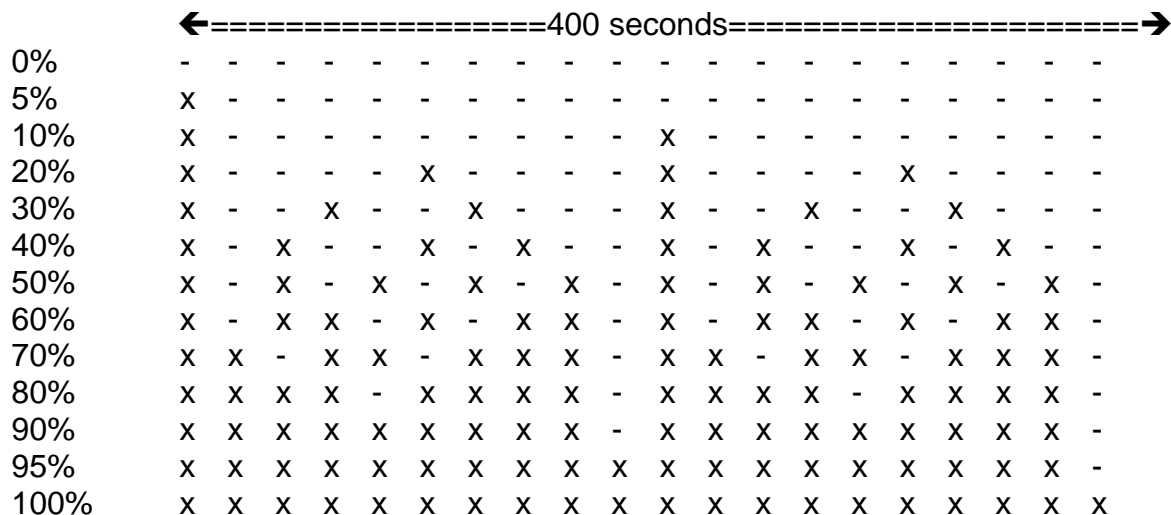

A 400-second example is shown because it will cover the patterns of the major percentages. The patterns for odd values such as 37% or 52% cannot be shown in a 400-second time interval but they would look very much like those patterns shown for 40% and 50% respectively. In an extreme case such as 99%, the relay would be on for 99 20-second blocks (1980 seconds) and then off for 1 20-second block (20 seconds) and then on for 1980 seconds and off for 20 seconds etc.

To determine the total amount of chemical fed over a 24 hour period, multiply the percent of time by the number of hours a day that your controller is operating, then multiply by your chemical pump flow rate per hour.

For example:

We select 10% of the time, our controller operates 24 hours a day and our chemical pump flow rate is 1 gallon per hour.

$$10\% \times 24 \frac{\text{hours}}{\text{Day}} \times \frac{1 \text{gallon}}{\text{Hour}} = \frac{2.4 \text{ Gallons}}{\text{Day}}$$

- From the **RELAY OPTIONS** screen press "4" **PERCENT OF TIME**.
- Use the keypad to enter the percentage of time desired. Press "ENT".

### 6.5.1.5 By Feed Schedule

---

The feed schedule is used to feed chemicals such as biocides on a time of day basis. Setting up the feed schedule is a two-part process. The first part is to configure the relay so that it will operate by feed schedule. The second part of the process is to configure the feed schedule. The feed schedule is covered in section 6.5.2.

- From the **RELAY OPTIONS** screen press "5" **FEED SCHEDULE**.

The controller will respond with the following screen.

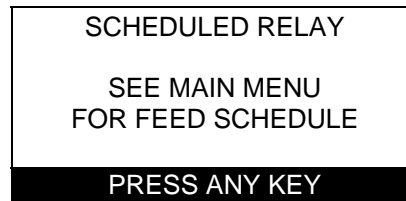

The relay has been configured to operate based on a feed schedule but, the relay will not activate because the feed schedule has not been programmed yet.

### 6.5.1.6 As an Alarm Relay

---

Relays 1, 2, 3, and 4 can be configured as alarm relays. The alarms that will cause the relay to activate are selectable from the controller alarms or from any node input alarms. The controller alarms include: **HIGH PH, LOW PH, HIGH REFERENCE IMPEDANCE, HIGH REFERENCE VOLTAGE, LOW REFERENCE VOLTAGE, BROKEN GLASS, FEED SEQUENCE ACTIVE, RLY1 TIME EXCEEDED, RELAY #2 TIME EXCEEDED, RELAY #3 TIME EXCEEDED, RELAY #4 TIME EXCEEDED**, and the **NO FLOW** alarm.

- From the **RELAY OPTIONS** screen press "6" **ALARM RELAY**. The controller will respond with the following screen.

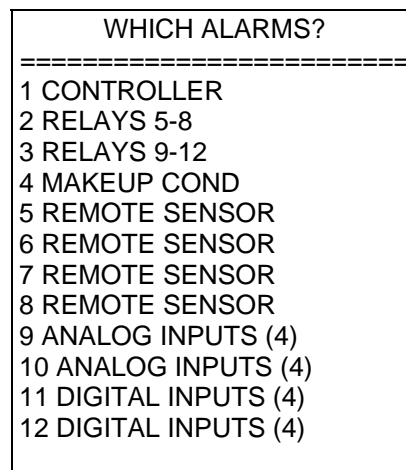

- Select the alarms from this menu that will activate the relay.



### 6.5.1.7 Change My Name

---

The name of each individual relay can be changed to any 4-character name. This is useful to designate the chemical name for each relay. Use the arrow keys to change the character and the ENT key to move to the next character.

<b>OLD NAME= RLY2</b>
<b>NEW NAME= ACID</b>
<b>&lt;UP&gt;&lt;DOWN&gt;ENT: ACCEPT</b>

- From the **RELAY OPTIONS** screen press "7" **CHANGE MY NAME**.

### 6.5.1.8 Scheduled Lockout?

---

This setting allows the user the choice of whether to lock out a relay during a scheduled feed sequence or not. If you do not want to lock out this relay during a scheduled feed sequence select **NO**.

<b>LOCK OUT RELAY DURING SCHEDULED FEED?</b>
=====
<b>1 * YES</b>
<b>2 NO</b>

- From the **RELAY OPTIONS** screen press "8" **SCHEDULED LOCKOUT?**.
- Press "1" **YES** to lock out the relay during a scheduled feed or press "2" **NO** to allow the relay to operate normally during a feed schedule.

**Note:** This setting is only available and visible when the relay is set to operate based on **SETPOINT, WATER METER, or PERCENT of TIME**.

## 6.5.2 Setting up the Feed Schedule

---

Refer to section 6.5.1.5 to configure a relay to feed based on the feed schedule before continuing with this section.

To get to the feed schedule menu:

- From the **MAIN MENU** press "3" **FEED SCHEDULE**. You will see the following screen:

```
FEED SCHEDULE
=====
1*BY WEEKDAY
2 BY CYCLE CALENDAR
3 LIST SCHEDULE
```

The feed schedule can be programmed to feed chemicals by either **WEEKDAY** or by a **CYCLE CALENDAR** basis.

**BY WEEKDAY** is used to feed chemicals by the weekday name, i.e. Monday, Tuesday, Wednesday etc. This is a seven-day schedule. At the end of the week, the schedule starts over again. To configure the feed schedule to feed by weekday:

- From the **FEED SCHEDULE** screen, press "1" **BY WEEKDAY**.

**BY CYCLE CALENDAR** is used to feed chemicals by a schedule other than one that is seven days long. **BY CYCLE CALENDAR** can be used to feed the same chemical every day or up to 28 days between feedings. The operator specifies the number of days in the cycle calendar. After the cycle calendar is completed, the schedule starts over again. This method of feeding is particularly useful when feeding two biocides on alternating weekly basis. To configure the feed schedule to feed by cycle calendar:

- From the **FEED SCHEDULE** screen, press "2" **BY CYCLE CALENDAR**.
- Use the keypad to enter the number of days in your cycle then press "ENT". Remember the maximum number of days allowed is 28.
- Use the keypad to enter which day today is in your cycle, e.g. today is day number 5 in my 14 day cycle, then press "ENT".

After selecting whether the feed schedule will be fed by **WEEKDAY** or by **CYCLE CALENDAR** it is time to actually program the schedule. To enter the actual feed schedule or to edit the feed schedule from the feed schedule screen above:

- Press "3" **LIST SCHEDULE**. This will take you to a list of all scheduled feeds as shown in the screen on the next page.

**NOTE:** The maximum number of scheduled feeds is 16 (sixteen) total.

FEED SCHEDULE			
=====			
1	01	03:00	RLY2
2	00	00:00	
3	00	00:00	
4	00	00:00	
5	00	00:00	
6	00	00:00	

- If there are no scheduled feeds, select the first schedule and press "ENT". If you are editing the schedule, select the schedule that you want to edit and press "ENT".

Below is an example screen for programming a chemical feed. Before programming a chemical feed, you need to configure Relay 1, 2, 3, or 4 to be a feed schedule relay.

<b>RELAY (ARROWS):</b>	<b>NONE</b>
<b>CYCLE DAY</b>	<b>: 0</b>
<b>START TIME</b>	<b>: 00:00</b>
<b>FEED DURATION</b>	<b>: 00:00</b>
<b>LOCKOUT TIME</b>	<b>: 00:00</b>
<b>&lt;UP&gt;&lt;DOWN&gt;ENT: ACCEPT</b>	

- To program the schedule use the keypad to enter the values in the above screen. Press "ENT" to move to the next item.

#### **NOTE: ALL TIMES ARE IN HOURS AND MINUTES**

**RELAY** is which relay you want to program (you must configure a relay to be a feed schedule relay first). Use the arrow keys to select the available relays. Only relays that have been configured as feed schedule relays will appear.

**CYCLE DAY** or **DAY** is the day you wish to actuate the feed schedule relay.

**START TIME** is the time you want to start the feed schedule sequence. This start time uses the 24 hour clock or military time. **06:00:00** is 6 a.m. **18:00:00** is 6 p.m.

**FEED DURATION** is the amount of time the feed schedule relay will be on.

**LOCKOUT TIME** after the feed duration is completed, an additional lockout time for **RLY 1, 2, 3,** and **4** relays can be programmed. The lockout time prevents the other relays from operating until this time expires. **Setting this time to 0:00 will disable this feature.**

### 6.5.3 Alarms

---

The Model 2350e is equipped with both high and low pH alarms. This menu option allows you to program the specific values for these alarms. When a pH alarm is received, it will appear as a flashing message in the middle of the display and any configured alarm relays will be activated. Consult your water treatment specialist when determining the proper High and Low Alarm values for your system.

To set the alarm setpoints:

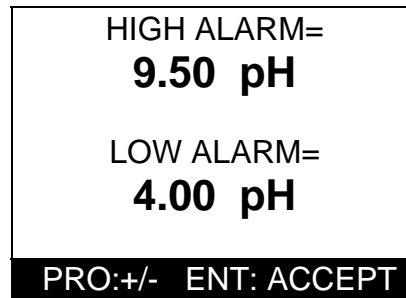

- From the **MAIN MENU** press "4" **ALARMS**. Use the keypad to enter a value for the high alarm. Press "ENT".
- Use the keypad to enter a value for the low alarm and press "ENT".
- Use the keypad to enter a value for the deadband and press "ENT". Refer to section 6.5.1.2.2 for a discussion on deadband.

### 6.5.4 Water Meters

---

The 2350e series controllers will work directly with the following types of meters: dry contacting head meters, Seametrics open collector output meters, Signet 2535 and 2540 paddle wheel meters, and the Autotrol 1 inch and 2 inch meters. Contact Lakewood Instruments for other types of water meters.

Both water meter inputs are programmed in the same manner.

To get to the water meter configuration screen:

- From the **main menu**, press "5" **WATER METERS**. This will take you to the **WHICH WATER METER SCREEN**.
- Press "1" for **MTR1** or press "2" for **MTR2**.
- This will take you to the **WATER METER TYPES** screen as shown on the next page.

WATER METER TYPES	
=====	
1	CONTACTING HEAD
2	PADDLE WHEEL
3	DATA INDUSTRIAL
4	SIGNET
5	<b>AUTOTROL TURB 1 IN.</b>
6	AUTOTROL TURB 2 IN.
7	CHANGE MY NAME

- Use the keypad to select the type of water meter that you are using.

The next screen is the **UNITS OF VOLUME** screen.

- The water meters can be configured for gallons or liters. Press "1" for **GALLONS** or press "2" for **LITERS**.

If **CONTACTING HEAD** was selected:

- You will be taken to the **GALLONS OR LITERS PER CONTACT** screen. Use the keypad to enter the number of gallons or liters per contact for your specific meter then press "ENT". You will then be asked if you want to reset the total count for that meter to zero. Press "1" for **YES** or press "2" for **NO**.

If **PADDLE WHEEL** was selected:

- You will be taken to the **PULSES PER GAL/LITER** screen. Use the keypad to enter the pulses per gal/liter for your particular water meter then press "ENT". You will then be asked if you want to reset the total count for that meter to zero. Press "1" for **YES** or press "2" for **NO**.

If **DATA INDUSTRIAL** was selected:

- You will be taken to the **SLOPE VALUE** screen. Use the keypad to enter the K factor and offset values for your particular water meter then press "ENT". You will then be asked if you want to reset the total count for that meter to zero. Press "1" for **YES** or press "2" for **NO**.

If **SIGNET** was selected:

- You will be taken to the **K-FACTOR** screen. Use the keypad to enter the K-factor for your particular water meter then press "ENT". You will then be asked if you want to reset the total count for that meter to zero. Press "1" for **YES** or press "2" for **NO**.

If **AUTOTROL TURB 1 IN.** was selected:

- The controller will confirm that the **AUTOTROL TURB 1 IN.** has been selected and you will be asked if you want to reset the total count for that meter to zero. Press "1" for **YES** or press "2" for **NO**.

If the **AUTOTROL TURB 2 IN.** is selected:

- The controller will confirm that the **AUTOTROL TURB 2 IN.** has been selected and you will be asked if you want to reset the total count for that meter to zero. Press "1" for **YES** or press "2" for **NO**.

## 6.5.5 4-20 mA OUTPUTS

---

If the -35L option is ordered the model 2350e has two channels of 4-20 mA output. The -35L is an option card that can be added in the field.

### 6.5.5.1 Set Up of the 4-20 mA Output

---

To set up the 4-20 mA output:

- From the **Main Menu**, press "6" **4-20 mA OUTPUTS**

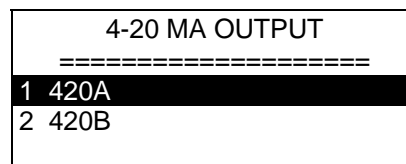

- Press "1" For **channel A** 4-20 mA OUT SETUP. Press "2" For **channel B** 4-20 mA OUT SETUP

The **4-20 mA Out Setup** screen allows the user to set the 4-20 mA range, calibrate the 4-20 mA output, select which process the 4-20 mA channel will respond to, take manual control of the 4-20 mA output, and change the name of the output. Below is the **4-20 mA Setup** screen.

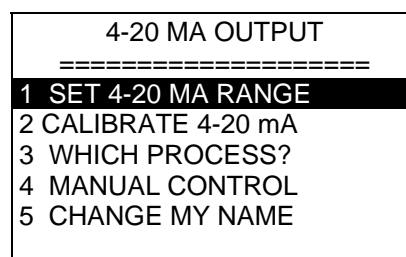

### 6.5.5.1.1 Set the 4-20 mA Range

---

The 4-20 mA output range must be set for the output to be useful.

- From the **4-20 mA Setup** screen, press "1" **Set the 4-20 mA RANGE**.
- Use the keypad to enter a pH value for the 4-mA point. Press "ENT".
- Use the keypad to enter a pH value for the 20-mA point. Press "ENT".

### 6.5.5.1.2 Calibrate

---

The 4-20 mA needs to be calibrated to the actual output to be accurate. A milliamp meter is necessary to calibrate the 4-20 mA output. Connect the milliamp meter in-line with one leg of the 4-20 mA output. Refer to the drawing in the back of this manual for wiring instructions.

- From the **4-20 mA Setup** screen, press "2" **CALIBRATE**.
- Use the keypad to enter the milliamp reading from the milliamp meter for the 4-mA point. Press "ENT".
- Use the keypad to enter the milliamp reading from the milliamp meter for the 20-mA point. Press "ENT".

### 6.5.5.1.3 Which Process?

---

If the model 2350e has any remote sensor nodes attached the 4-20 mA channel can be configured to operate based on that input.

- From the **4-20 mA Setup** screen, press "3" **WHICH PROCESS?**
- Use the up and down arrow keys to select the process that will control the 4-20 mA output. Press "ENT".

### 6.5.5.1.4 Manual Control

---

Manual control is used to temporarily change the 4-20 mA output.

- From the **4-20 mA Setup** screen, press "4" **MANUAL CONTROL**.
- Use the up and down arrow keys to raise or lower the 4-20 mA output. To exit this screen press "CLR".

### 6.5.5.1.5 Change My Name

---

The name of the 4-20 mA output can be changed by the operator.

- From the **4-20 mA Setup** screen, press "5" **CHANGE MY NAME**.
- Use the arrow keys to change the characters, use the ENT key to move the cursor to the next character.

## 6.5.6 The System Setup Menu

---

The system setup menu is used to set up the temperature compensation, damping, initialize the controller, digital inputs, check the firmware version, change the security passwords, check the diagnostics, set up the communications, and node installation.

### 6.5.6.1 Process Parameters

---

The process parameters screen is used to change the name of the process, set up the temperature compensation, and set the damping.

#### 6.5.6.1.1 Change My Name

---

The name of the process can be changed from **pH** to a different 4-character name.

To change the name of the process:

- From the Main Menu press **"7" SYSTEM SETUP.**
- Press **"1" PROCESS PARAMETERS.**
- Press **"1" CHANGE MY NAME.**
- Use the arrow keys to change the characters, use the ENT key to move the cursor to the next character.

#### 6.5.6.1.2 Temperature Compensation

---

Most Lakewood Instruments pH sensors are temperature compensated with the exception of the cooling tower pH sensors. The default value for the model 2350e is **NONE**. If you are using a pH sensor that has a temperature compensator you can select the temperature compensator value for your sensor.

To set up the temperature compensation:

- From the Main Menu press **"7" SYSTEM SETUP.**
- Press **"1" PROCESS PARAMETERS.**
- Press **"2" TEMP COMPENSATION**
- Select the value of your temperature compensator. Press **"ENT"**.



### 6.5.6.1.3 pH PER °C

---

The nominal value for temperature compensation in cooling towers is 2% per °C. If this value is not correct for your application the compensation value can be changed.

To change the temperature compensation value:

- From the **Main Menu** press "7" **SYSTEM SETUP**.
- Press "1" **PROCESS PARAMETERS**.
- Press "3" **pH PER °C**.
- Use the keypad to enter a pH value per °C. Press "**ENT**".

### 6.5.6.1.4 Damping

---

The rate of change of the pH value can be slowed down using DAMPING. If the pH value is changing quickly you can slow it down by:

- From the **Main Menu** press "7" **SYSTEM SETUP**.
- Press "1" **PROCESS PARAMETERS**.
- Press "4" **DAMPING**.
- Use the keypad to change the DAMPING value. Input a larger number to slow the rate of change down or a smaller number to speed it up. Press "**ENT**".

### 6.5.6.2 Initialization

---

Initialization restores the factory default settings to the controller. The whole controller can be initialized or just the calibration. It is suggested that you initialize the whole controller before you program the controller. This will clear any random settings that may be in the controller. To do so, follow these instructions:

- From the **Main Menu**, press "7" **SYSTEM SETUP**.
- Press "2" **INITIALIZATION**.
- Press "2" **WHOLE CONTROLLER** and press "**ENT**". A warning will appear on the screen (see below). Press "1" to proceed, "2" to cancel.

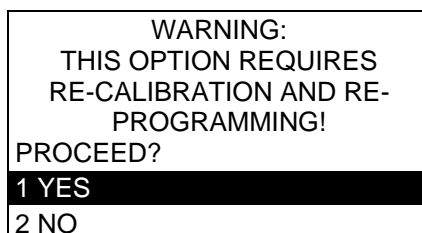

To initialize just the calibration:

- Press "1" **CALIBRATIONS** instead of "2" **WHOLE CONTROLLER** in the procedure above. The same warning screen will appear.

### 6.5.6.3 Digital Inputs

---

If the model 2350e controller has a digital input node (NDIG) installed the inputs are configured from this screen. If a NDIG is not installed there is no access to this menu item. Configuration of the digital inputs are covered in the NDIG manual.

### 6.5.6.4 Firmware Versions

---

Sometimes it is necessary to verify the firmware version of the controller for troubleshooting purposes. To obtain the firmware versions:

- From the **Main Menu**, press **"7"** **SYSTEM SETUP**.
- Press **"4"** **FIRMWARE VERSION**.
- The firmware versions will be displayed. Use the arrow keys to see all firmware versions. To exit this screen, press **"CLR"**.

### 6.5.6.5 Change the Security Passwords

---

The security password can be changed from the factory default settings to any four-digit value of your choice.

To change the security passwords:

- From the **Main Menu**, press **"7"** **SYSTEM SETUP**.
- Press **"5"** **SECURITY**.

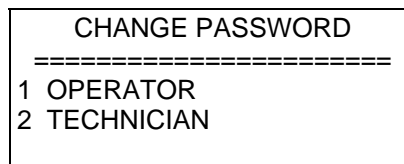

- Press **"1"** **OPERATOR** to change the operator password or Press **"2"** **TECHNICIAN** to change the technician password.
- Use the keypad to enter the old password. If the password has not been changed before, the old password for **OPERATOR** is **1111** and the password for **TECHNICIAN** is **2222**.
- Use the keypad to enter the new password.
- Use the keypad to enter the new password a second time for verification

If you lose your password, contact Lakewood Instruments for assistance.

### 6.5.6.6 Diagnostics

---

The diagnostics screen is used for troubleshooting purposes. Contact Lakewood Instruments for assistance.

### 6.5.6.7 Communications

---

The model 2350e has an option for remote communications, the –RS2L option. If this option is installed the communications option is configured from this screen. This screen is used to set up the com port, initialize the modem, and set the remote password.

To set up the communications option:

- From the **Main Menu**, press "7" **SYSTEM SETUP**.
- Press "7" **COMMUNICATIONS**.

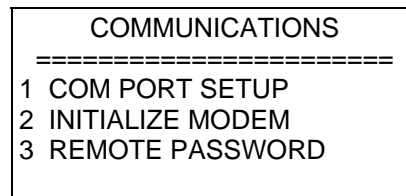

#### 6.5.6.7.1 Com Port Setup

---

Com port setup is used to set up the com port for use with a modem or direct connect.

- To set up the com port press "1" **COM PORT SETUP**

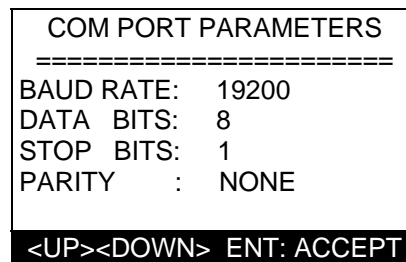

- Use the arrow keys to change the baud rate. If using the direct connect method of communicating, ensure that the baud rate at the controller and the baud rate in the LRWS software match.
- The standard values for the **DATA BITS** is 8, **STOP BITS** is 1, and **PARITY** is NONE. Normally these will not need to be changed.

### 6.5.6.7.2 Initialize Modem

---

Before a modem can be used by the controller it must be initialized. The initialization screen gives four choices of modems.

To initialize the modem:

- From the Communications menu, press “**2**” **INITIALIZE MODEM**

```
INITIALIZE MODEM
=====
1 HAYES ACCURA
2 U.S. ROBOTICS
3 ZOOM
4 OTHER MODEM
```

- Select your modem from the list. If your modem is not listed and you select **OTHER MODEM** use the keypad to enter the initialization string for your modem.
- If the modem fails to initialize, check the 25-pin connector, the phone cable, the modem, and the –RS2L option card.

### 6.5.6.7.3 Remote Password

---

Remote communications to the Lakewood Instruments 2000 series controllers is protected with an 8-digit password. The remote password is required to make changes to the model 2350e controller using the communications option card.

The remote password screen in the communications menu is used to change the remote password. The remote password can only be changed at the controller.

To change the remote password:

- From the communications menu, press “**3**” **REMOTE PASSWORD**.
- Use the keypad to enter the old password. Enter the new password. Repeat the new password again for verification. **NOTE: The default password is 12345678.**
- Set the remote password in the LRWS program to match the new password for this controller.

### 6.5.6.8 Node Installation

---

The node installation menus is used to install new nodes and to de-install installed nodes. Please refer to your node manual for information on node installation.

## 6.5.7 Setting the Clock

---

The clock uses the 24 hour or military time. **06:00:00** is 6 a.m. **18:00:00** is 6 p.m. To set the clock:

- From the **Main Menu** press **"8"** **CLOCK**. The following screen will appear:

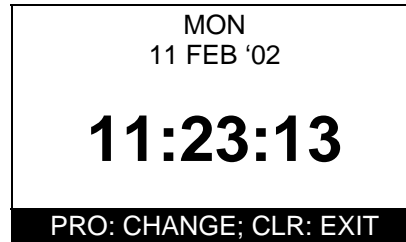

- Press **"PRO"** to change the clock settings.
- Use the up and down arrow keys to change the day of the week. Press **"ENT"**.
- Use the number keys to change the date. Press **"ENT"**.
- Use the arrow keys to change the month. Press **"ENT"**.
- Use the number keys to change the year. Press **"ENT"**.
- Use the number keys to change the hour. Press **"ENT"**.
- Use the number keys to change the minutes. Press **"ENT"**.
- Use the number keys to change the seconds. Press **"ENT"**.
- Press **"CLR"** to exit this screen.

You must press **"ENT"** all the way through this menu for the settings to take affect.

## 6.5.8 Changing the Security Levels

---

The security level can be change to prevent any unwanted tampering of the controller. To change the security level from **Technician** to **Operator** or **View-Only**:

- From the **Main Menu**, press **"0"**. (*Note that "0" does not appear on the menu screen.*)

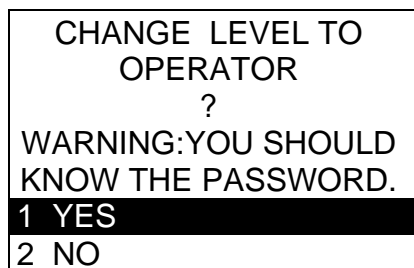

- Select **YES** to change the security level to a more restrictive level.

The controller menu now functions at the new security level.

To return to the **Technician** security level:

- Press the numeric password from the **Process** screen:



**Remember that following the first power-up the Technician password is 2222 and the Operator password is 1111. You may change the passwords in the SYSTEM SETUP menu.**

## **7.0 Maintenance**

---

Periodic maintenance is required to ensure trouble free operation of the model 2350e controller. The following sections cover the required maintenance.

### **7.1 Sensor Maintenance**

---

Routine maintenance is necessary in order to maximize the efficiency and accuracy of your sensor. Clean the electrode end of the pH sensor at least once per month. Cleaning of the pH sensor may need to be performed more frequently if it is in a high fouling environment.

- Remove power from the controller and shut off the sample flow.
- Remove the sensor from its plumbing.
- Be careful not to touch the glass electrode. Do not use cloth to clean the electrode. Cloth has oils that will foul the sensor.
- If there is oil on the sensor glass, use isopropyl alcohol to clean the electrode.
- It is recommended that you use a 10% Muriatic or HCL acid to clean the sensor.
- Wash the sensor off with tap water.
- Install the sensor in its plumbing.
- Restore sample flow and check for leaks.
- Restore power to the controller.
- Allow the reading to stabilize for approximately 30 minutes.
- Perform a calibration of the pH.

## 7.2 Flow Switch Maintenance

---

If you have the flow switch plumbing assembly, you may need to periodically clean the wetted parts in this assembly.

- Shut off the inlet flow and the power to the controller.
- Turn the red lock ring for the flow switch counterclockwise.
- Pull out the clear flow sight tube and remove the float with your fingers.
- Use a bottlebrush on the float, flow sight and the flow switch assembly to remove any residue.
- Clean and lubricate the “O” ring with a silicone-based lubricant (petroleum-based lubricants will cause the O-ring to swell).
- Lock down the red lock ring after you replace the components.
- Turn the inlet flow back on and check for leaks.

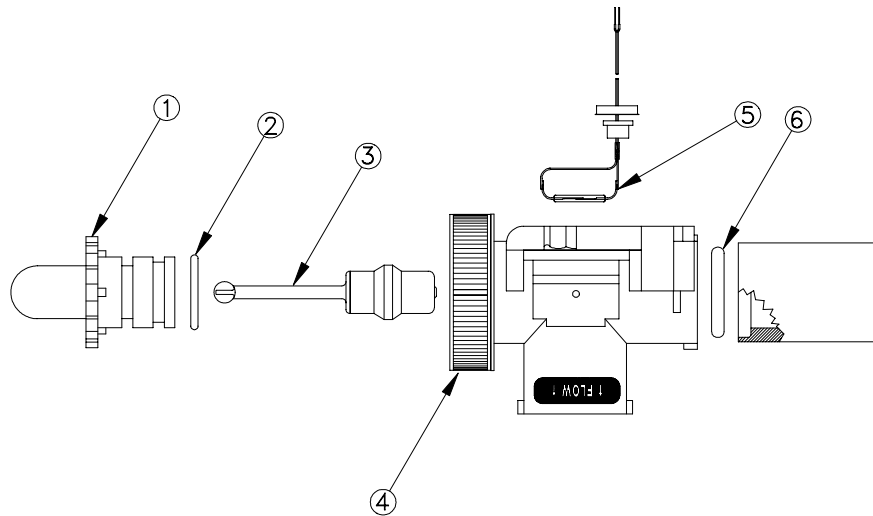

***FlowSwitchAssembly***

Find No.	Part No.	Part Description
1	1167266	Flowsight
2	1166418	O-Ring (flow sight)
3	1167234	Flow Magnet
4	1169740	Red Locking Ring Kit
5	1107004	Reed Switch
6	1166417	O-Ring (check valve)

### **7.2.1 Replacing the Reed Switch**

---

If you ever need to replace the reed switch for the flow switch, follow the procedure below.

- Remove the power to the controller and shut off the sample flow.
- Disconnect the flow switch wires from the controller.
- Remove the screws holding the flow switch plumbing assembly and disconnect flow switch assembly from piping, if necessary to gain access to the reed switch.
- Pull hard on the wires that go to the reed switch assembly to remove the reed switch from the plumbing assembly.
- Push the new reed switch into the plumbing assembly and wire the new reed switch to the controller.
- Re-install plumbing.
- Restore flow to the plumbing assembly and check for leaks.
- Restore power to the controller.

### **7.3 Replacing the Fuse**

---

The Model 2350e contains a 10A, 250V fuse. The fuse holder is located on the bottom of the enclosure. It is accessible from the outside of the box. Replacement fuses must be a fast blow type. If the fuse is blown, the display will be blank and the four power supply lights inside the controller enclosure will be dark when the unit is connected to power. Refer to the troubleshooting section of this manual for more information about blank displays.



## 8.0 Troubleshooting

### 8.1 Error Messages

This section discusses some of the more common questions with the Model 2350e. These notes are not intended to be all-inclusive—only to cover the most common situations. If you have other questions or are need support, contact the Lakewood Instruments Technical Service Department toll free at (800) 228-0839.

PROBLEM	WHAT THIS MEANS	CORRECTIVE ACTION
<b>{Alarm Flashing} “pH: HIGH ALARM”.</b>	pH is too high with respect to the high alarm setpoint.	<ol style="list-style-type: none"> <li>1. See {RLY: TIME EXCEEDED}.</li> <li>2. Check the High Alarm Value.</li> <li>3. Check relay setpoints and deadbands.</li> <li>4. Check chemical drum levels.</li> <li>5. Check proper operation of chemical pumps.</li> </ol>
<b>{Alarm Flashing} “pH: LOW ALARM”.</b>	pH is too low with respect to the low alarm setpoint.	<ol style="list-style-type: none"> <li>1. See {RLY: TIME EXCEEDED}.</li> <li>2. Check the Low Alarm Value.</li> <li>3. Check relay setpoints and deadbands.</li> <li>4. Check chemical drum levels.</li> </ol>
<b>Water meters not accumulating.</b>	<p>There may be a problem with the wiring or the reed switch in the meter may be bad.</p> <p>For water meters other than the contacting head type, check the manufacturer’s user manual for that particular water meter.</p>	<ol style="list-style-type: none"> <li>1. Approximately 24 volts DC should be present at the input terminal when the water meter contact is closed. That should change to zero VDC when the contact opens. Check these voltages and for correct wiring.</li> <li>2. Is the controller configured for your type of water meter?</li> </ol>
<b>{Alarm Flashing} “FEED SEQUENCE ACTIVE”.</b>	This simply indicates that a feed schedule relay is active.	No action necessary.
<b>Display is blank.</b>	There may be a problem with the incoming power, the fuse or the circuit board. Open the front panel to troubleshoot.	<ol style="list-style-type: none"> <li>1. Check the fuse. Replace if blown.</li> <li>2. Does the unit have power? Verify with volt meter.</li> <li>3. If there is power to terminals LINE and NEUTRAL on TA, call Lakewood Instruments Technical Service for more information.</li> </ol>

PROBLEM	WHAT THIS MEANS	CORRECTIVE ACTION
<p><b>{Alarm Flashing}</b>  <b>“RLY: TIME EXCEEDED”.</b></p>	<p>This indicates that the controller has been trying to feed chemical for longer than the user-programmed time and is unable to reach the setpoint.</p>	<ol style="list-style-type: none"> <li>1. Check for proper operation of pump. Use the manual relay control to help.</li> <li>2. Check that the chemical drum is not empty.</li> <li>3. Check for power to the chemical pump.</li> <li>4. Verify the relay timeout time is properly set for your application (see RELAYS in MAIN menu).</li> <li>5. To reset this alarm, momentarily turn off flow to the controller to get the no flow alarm.</li> </ol>
<p><b>“NO FLOW” alarm.</b></p>	<p>Flow input switch is not closed.</p>	<ol style="list-style-type: none"> <li>1. The flow switch float may be stuck or no flow is present.</li> <li>2. Flow switch may be bad. Replace reed switch in plumbing assembly.</li> </ol> <p>If no flow switch is used, a jumper wire should be installed across the flow switch input. Removing the jumper disables all relay outputs.</p>

## 9.0 Factory Service

---



Technical Support for Lakewood Instruments can be reached by calling (800) 228-0839 or faxing (414) 355-3508, Monday through Friday, 7:30 a.m. – 5.00 p.m. CST.

***NOTE: IF YOU CALL FOR TROUBLESHOOTING HELP, PLEASE HAVE THE MODEL NUMBER, SERIAL NUMBER, AND ANY OPTIONS PERTAINING TO YOUR UNIT AVAILABLE FOR REFERENCE.***



Mail and returns should be sent to:

**Lakewood Instruments  
7838 North Faulkner Road  
Milwaukee, WI 53224 USA**

When any merchandise is to be returned to the factory, please call and obtain a Return Goods Authorization (RGA) number and have the following information available:

- Customer's name, address, telephone and fax numbers (shipping and billing).
- A hard copy purchase order number for cases where repairs or parts are required that are not under warranty.
- A contact person's name and telephone number to call if the equipment is beyond repair or to discuss any other warranty matter.
- Equipment model and serial numbers.
- Reason for return, e.g., repair, warranty, incorrect part, etc.

We will then fax to your attention an RGA form that must accompany the returned item.

***NOTE: THE RGA NUMBER MUST BE CLEARLY WRITTEN ON THE OUTSIDE OF THE PACKAGE(S) BEING RETURNED.***

**ANY ITEMS SENT BACK TO THE FACTORY  
WITHOUT AN RGA NUMBER WILL BE REFUSED  
AND RETURNED TO SENDER**

## **Parts List and Service Guide**

When calling Lakewood Instruments, please have your controller's complete model number and serial number available, together with the firmware version so that the Technician can better assist you.

Refer to the Ordering Information section of this manual for part numbered replacement parts.

Write your controller's complete model number, serial number, and firmware version here so that you will have them available if you wish to contact a Lakewood Instruments technician.

Model Number:

Serial Number:

Firmware Version:

## 10.0 Drawings

---

NOTES: UNLESS OTHERWISE SPECIFIED:

REVISIONS			
REV	DESCRIPTION	DATE	APPROVAL
A	ECO 10042	PSG 2-1-07	

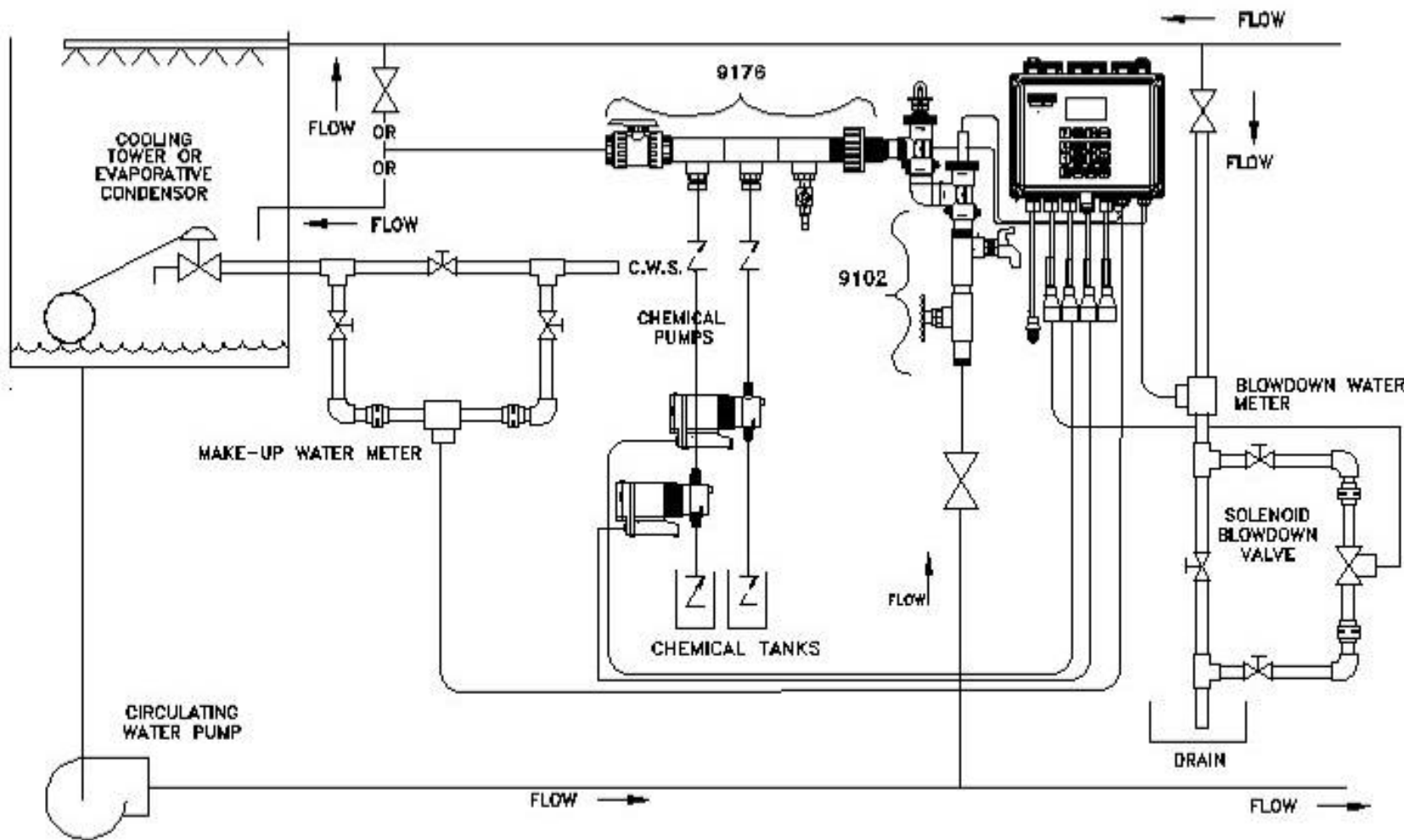

		<b>RECOMMENDED INSTALLATION</b> <b>COOLING TOWER</b> <b>CONTROL SYSTEM</b> <b>2300g</b>	
RECT. AREA/INCHES PERIOD. OR APPLICATIONS	2.400 = 2.400 2.400 = 2.400	11/2/00	A 1268657_2a A NONE NONE 1 OF 1

REVISION HISTORY					
REV	DESCRIPTION	EDD	DWH	DATE	APVD
A	RELEASE	10042	PSC	2-1-07	

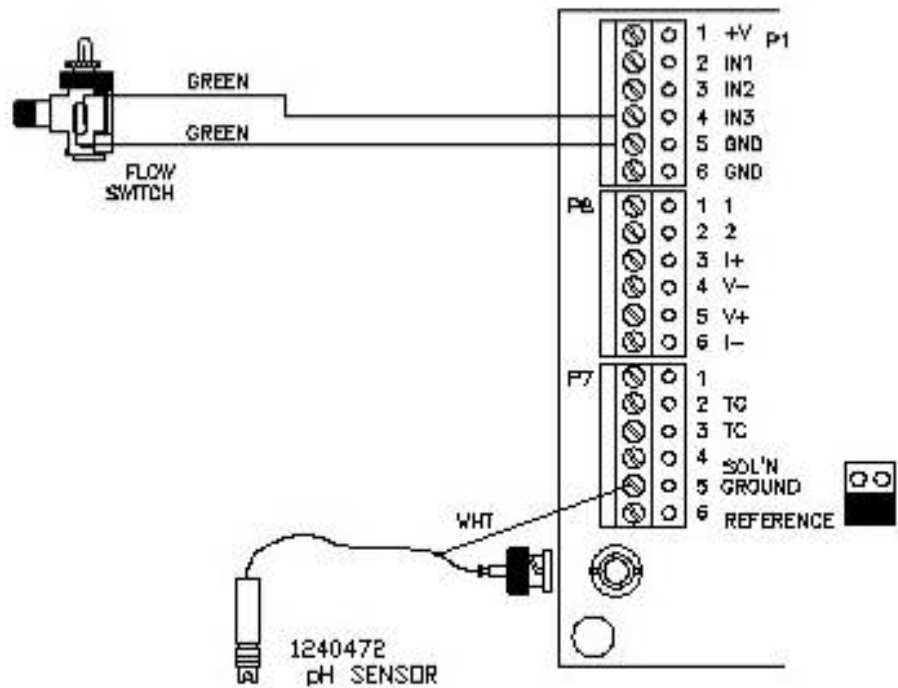

NOTICE ON REPRODUCTIONS THIS DRAWING IS THE PROPERTY OF LAKWOOD INSTRUMENTS. IT IS TO BE USED ONLY FOR THE PROJECT AND QUANTITY SPECIFIED. ANY REUSE OR REPRODUCTION WITHOUT WRITTEN PERMISSION IS PROHIBITED.					
MATERIAL: FRAC. DIMENSIONS: DECIMALS. FINISH: AWG/GAUGE.			TITLE: WIRING DIAGRAM SENSOR WIRING, LOW POWER M-2350e		
ORDER NO.	DWH	PSC	DATE	2-1-07	REV
CUSTOMER	GRD		DATE		A
CUSTOMER LOC.	APVD		DATE		
DO NOT SCALE	APVD		DATE		
SCALE: NONE		FILE TYPE: DWG		SHEET 1 OF 1	

ENR 02/01/06 REV 04-06

NOTES: UNLESS OTHERWISE SPECIFIED;

- 1 2450: CANNOT BE USED WITH CONTACTING HEAD METER.
- 2 2450: METER 1 IS PERMEATE, METER 2 IS CONCENTRATE.
- 3 CUSTOMER SUPPLIED, 10K RESISTOR (PULL-UP).
- 4 ONLY OPEN COLLECTOR OUTPUT WATER METERS MAY BE USED.

REVISION HISTORY						
REV	DATE	DESCRIPTION	BY	APP	DATE	APP
A		RELEASE	1121	EV	01/03/97	
B		RELEASE	0280	EV	02/04/97	
D		RELEASE	0287	EV	10/01/97	
D		RELEASE	1480	EV	11/03/97	JSD
E		ADDED METER 2	1594	EV	02/18/98	JSD
F		REMOVED METER 1, 4000 DUMP	1743	EV	02/18/98	

1 CONTACTING HEAD TYPE WATER METER

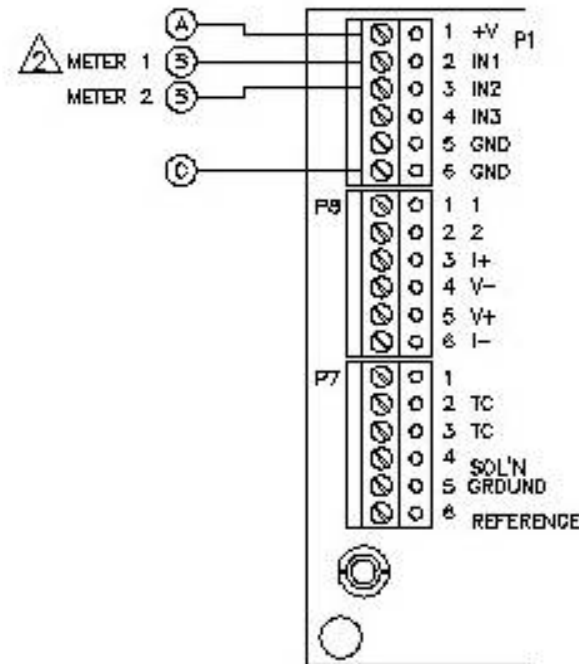
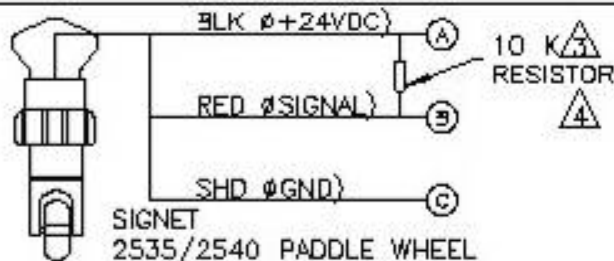
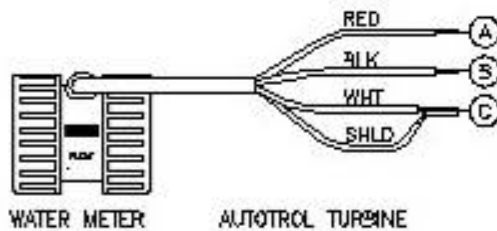
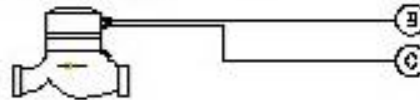

NOTICE TO INDENTIFIERS				Lakewood INSTRUMENTS	
DATE	REV	DESCRIPTION	BY	APP	DATE
		02 2/97			
		028 2/98			
ORDER NO.	REV	DATE	BY	APP	DATE
		02/18/98			
REVISION	DATE	BY	APP	DATE	BY
		02/18/98			
REVISION	DATE	BY	APP	DATE	BY
		02/18/98			
DO NOT SCALE	DATE	BY	APP	DATE	BY
		02/18/98			
TITLE				WATER METER INPUTS, W-2000 SERIES	
DRAWING NO.				1109544-24	
REV				F	



REVISION		REVISION HISTORY			
DWG	PART	DESCRIPTION	ECO	DWN/DATE	APV/DATE
A	A	RELEASE	10042	PSG/ 5-3-06	LRS/ 7-28-06

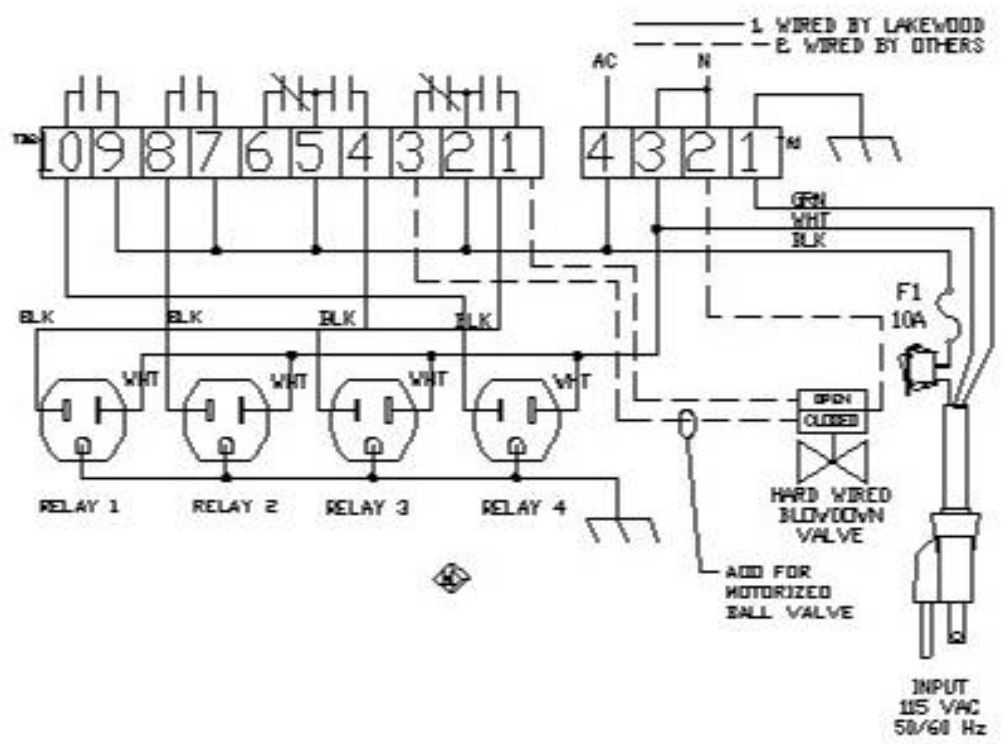

**NOTICE ON REPRODUCTIONS**  
 THIS DRAWING, THE DESIGN AND THE PATENTS IT COVERS ARE THE PROPERTY OF LAKEWOOD INSTRUMENTS INC. THEY ARE LOANED MERELY TO THE BORROWER FOR HIS USE AND MUST NOT BE REPRODUCED, COPIED, LOANED, QUOTED, REPRODUCED OR USED IN ANY MANNER AND THE BORROWER USE HEREBY AGREES TO HOLD LAKEWOOD INSTRUMENTS INC. HARMLESS FROM ANY AND ALL LIABILITY THAT MAY BE INCURRED BY THE BORROWER.



**DIMENSIONING AND TOLERANCING PER ASME Y14.5M-1994**

MATERIAL	TOLERANCES UNLESS NOTED	
	SIZES X ± XX ± XXX ±	ANGLES ±
FINISH	DWN PSG	DATE 5-3-06
	CHKD RCL	DATE 7-28-06
PROJECT	APVD LRS	DATE 7-28-06
	LIBRARY	VERSION

TITLE				REV
WIRING DIAGRAM, 2000 SERIES NEMA ENCLOSURE				
SIZE	PN	REV	DATE	REV
A	1268647	A	5-3-06	A
SCALE	SHEET	DWG NO	DATE	REV
NTS	1	1268647-1a	7-28-06	A

REVISION HISTORY					
REV	DESCRIPTION	EOO	D/W	DATE	APVD
A	RELEASE	10042	PSG	1-16-08	

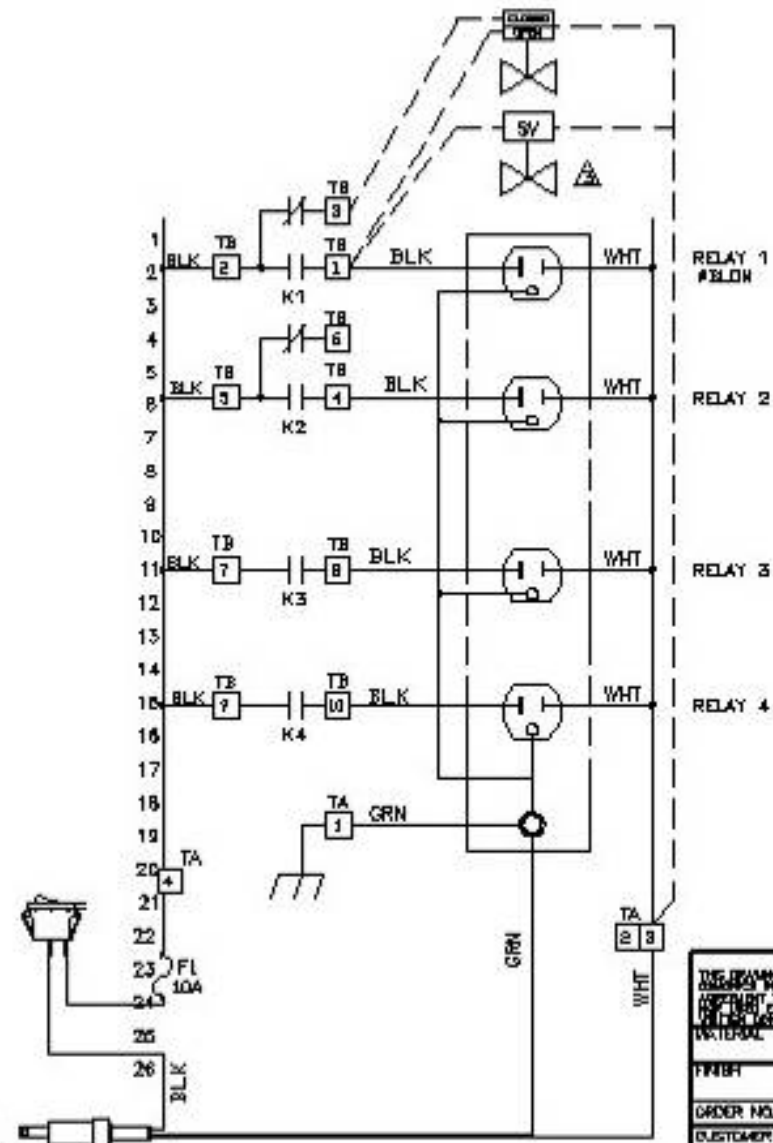

1. WIRING BY LAKEWOOD \_\_\_\_\_
2. WIRING BY OTHERS - - - - -
- ⚠ IF RECEPTACLE NOT USED, WIRE BLOWDOWN VALVE BETWEEN TB1 AND TAs
4. RELAY CONTACTS RATED 10A / 250 VAC, 1/3-P / 240 VAC

115 VAC  
50 / 60 Hz

NOTICE ON REPRODUCTIONS THIS DRAWING IS THE PROPERTY OF LAKEWOOD INSTRUMENTS. IT IS TO BE USED ONLY FOR THE PROJECT AND QUANTITY SPECIFIED. ANY REUSE OR REPRODUCTION WITHOUT THE WRITTEN PERMISSION OF LAKEWOOD INSTRUMENTS IS PROHIBITED.																															
<table border="1"> <tr> <td>DATE</td> <td>FRAC</td> <td>DECIMALS</td> <td>ANGLES</td> </tr> <tr> <td></td> <td>16</td> <td>2</td> <td>1</td> </tr> <tr> <td></td> <td>1/16</td> <td>1/32</td> <td>1/8</td> </tr> <tr> <td></td> <td>1/32</td> <td>1/64</td> <td>1/16</td> </tr> </table>				DATE	FRAC	DECIMALS	ANGLES		16	2	1		1/16	1/32	1/8		1/32	1/64	1/16	<table border="1"> <tr> <td colspan="2">TITLE</td> <td rowspan="2"> </td> <td rowspan="2">REV</td> </tr> <tr> <td colspan="2">ELECTRICAL SCHEMATIC</td> <td>1268547-2a</td> <td>A</td> </tr> <tr> <td colspan="2">2000 SERIES, NEMA ENCLOSURE</td> <td></td> <td></td> </tr> </table>		TITLE			REV	ELECTRICAL SCHEMATIC		1268547-2a	A	2000 SERIES, NEMA ENCLOSURE	
DATE	FRAC	DECIMALS	ANGLES																												
	16	2	1																												
	1/16	1/32	1/8																												
	1/32	1/64	1/16																												
TITLE			REV																												
ELECTRICAL SCHEMATIC				1268547-2a	A																										
2000 SERIES, NEMA ENCLOSURE																															
ORDER NO.	D/W	PSG	DATE 11-16-08	SCALE	1:1	FILE TYPE	DWG	SHEET	1 OF 1																						
CUSTOMER	APVD	DATE		SCALE	NONE	FILE TYPE	DWG	SHEET	1 OF 1																						
CUSTOMER LOC.	APVD	DATE		SCALE	NONE	FILE TYPE	DWG	SHEET	1 OF 1																						
DO NOT SCALE	APVD	DATE		SCALE	NONE	FILE TYPE	DWG	SHEET	1 OF 1																						

DO NOT SCALE

FOR INSTRUMENTS RELEASE

NOTES: UNLESS OTHERWISE SPECIFIED:  
 ⚠ STANDARD FOUR CONDUCTOR TELEPHONE CABLE  
 UP TO 50 FEET IN LENGTH MAY BE SUBSTITUTED.

REVISION HISTORY					
REV	DATE	DESCRIPTION	BY	CHKD	APPD
A		RELEASE	DMT	MLM	1/78
B		DESIGN	DMT	MLM	1/78
C		REVISED	DMT	ML	10/8/77
D		REVISED	DMT	ML	11/14/77

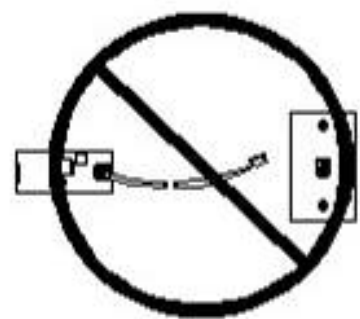
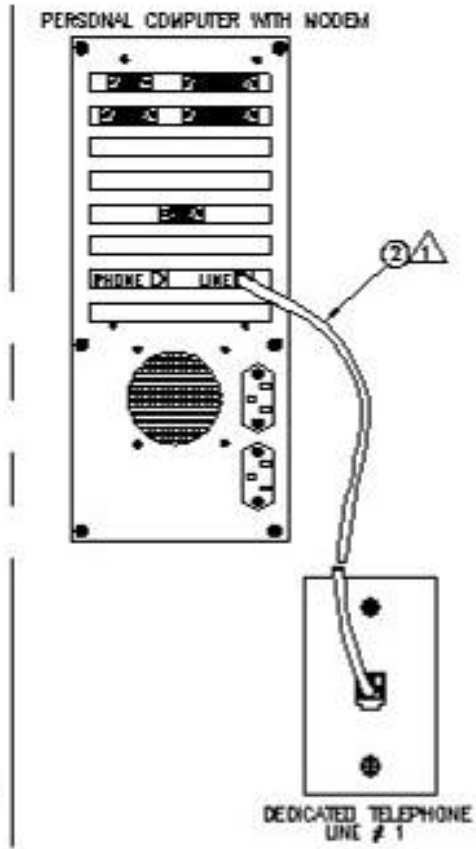
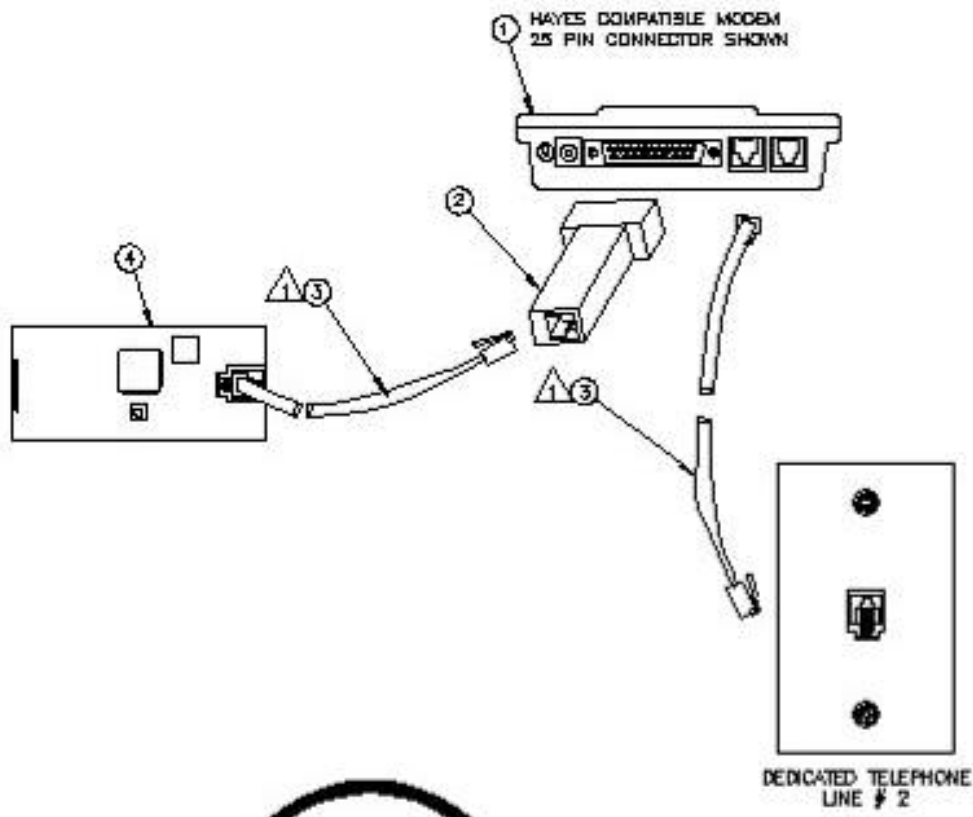

**DO NOT PLUG RJ22B DIRECTLY INTO TELEPHONE LINES**

1	RS2L	RS2L COM MODE	ASSEMBLED PCB, M-2000	4
1	66336	CABLE, RJ21, 25 FT.		3
1	67760	ADAPTER	25 P MALE D CONN TO RJ21 DTE	2
1	67740	MODEM	HAYES COMPATIBLE	1

INSTR. SUPP.  
 WORK IN PROGRESS  
**Labrador INSTRUMENTS**  
 INSTALLATION LAYOUT  
 COINODE TO 25P DTE, SER 2000, RS2L  
 1109706-1d  
 REV D

NOTES: UNLESS OTHERWISE SPECIFIED;

⚠ STANDARD FOUR CONDUCTOR TELEPHONE CABLE UP TO 50 FEET IN LENGTH MAY BE SUBSTITUTED.

REVISION HISTORY					
REV	DATE	DESCRIPTION	CHK	APP	DATE
A	02/06/86	RELEASE	1367	DJ	10/8/87
B		REWORK	1367	DJ	10/8/87
B		REWORK	148	DJ	11/14/87

PERSONAL COMPUTER WITH MODEM

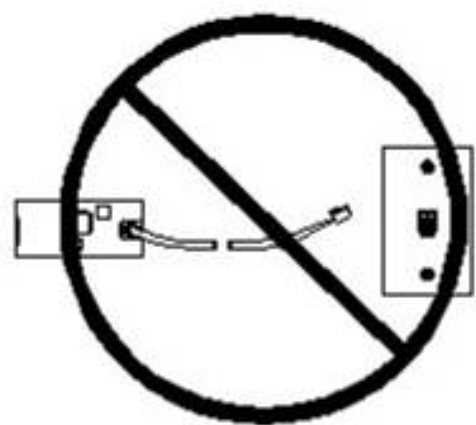
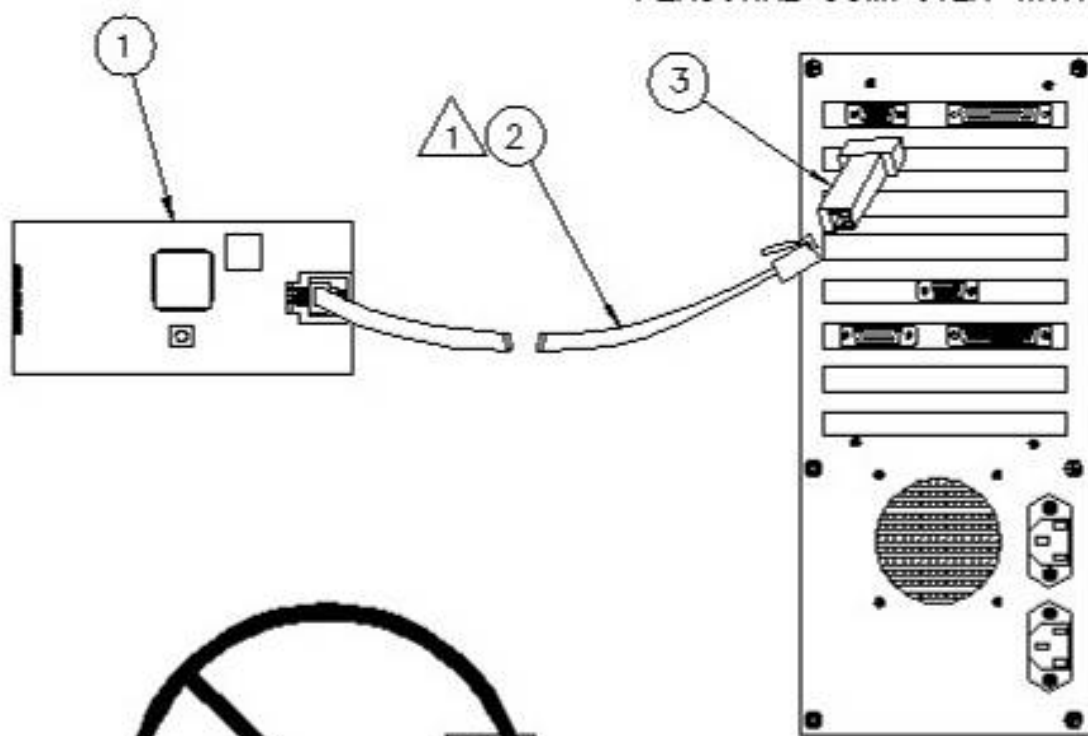

DO NOT PLUG RS232 DIRECTLY INTO TELEPHONE LINES

1	87000	ADAPTER, 8 PIN	MALE DOWN TO RJ11 DTE	3
1	88336	CABLE, RJ11	25 FT	2
1	RS232	RS232 COM MODEM	ASSEMBLED PCB, M-2000	1

PARTS LIST		REVISIONS	
REV	DATE	DESCRIPTION	BY

		<b>Labwood</b> INSTRUMENTS	
INSTALLATION LAYOUT RS232 DIRECT CONNECT TO 8 PIN, RS232			

NOTES: UNLESS OTHERWISE SPECIFIED;  
 1. LOADS MUST BE LESS THAN 600Ω

REVISION HISTORY						
REV	CODE	DESCRIPTION	ISS	BY	DATE	APP'D
A		RELEASE	8767	BJ	8/88	
B		REVISED	087	BJ	10/3/87	

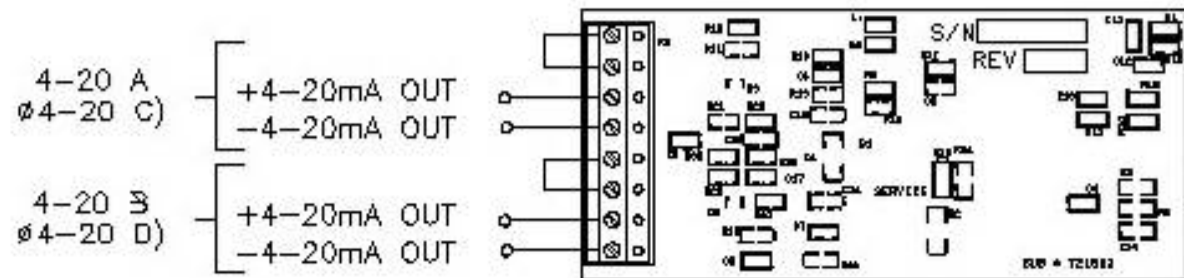

INTERNAL POWER

OPTIONAL EXTERNAL 24 VDC SUPPLY

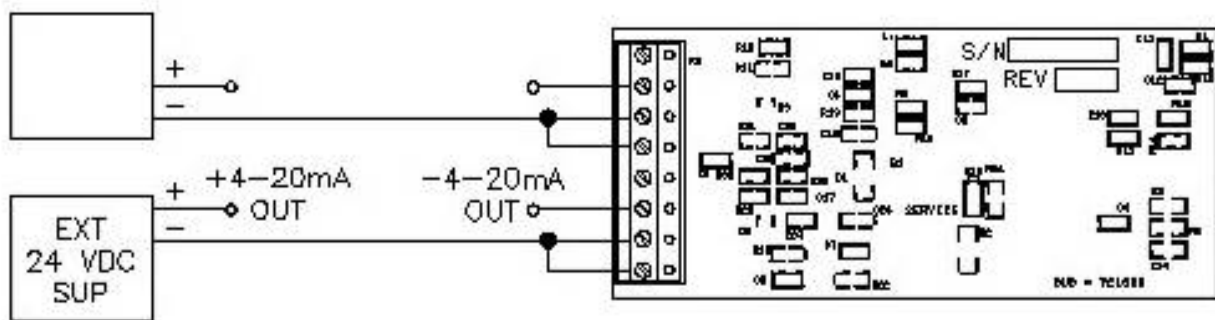

PRINT OR REPRODUCTION				Lakewood INSTRUMENTS	
DATE	TIME	BY	CHKD	DATE	TIME
ORDER NO.	REV	MAN	DATE/08	TEL	1109707-1b
DATE/08	REV	DATE	DATE	REV	B
DO NOT SCALE	APP'D	DATE	SCALE	FILE TYPE	APP'D

WIRING DIAGRAM  
 POWER SUPPLY, 24VDC 4 TO 20 mA

NOTES: UNLESS OTHERWISE SPECIFIED;

1. NIN OPTION PROVIDES +24 VDC TO ALL NODES. IF USING MORE THAN 3 NODES AN EXTERNAL +24 VDC POWER SUPPLY IN PARALLEL IS RECOMMENDED.

REVISION HISTORY					
REV	DATE	DESCRIPTION	BY	CHKD	APP'D
A		RELEASE	END	BY	5/3/87

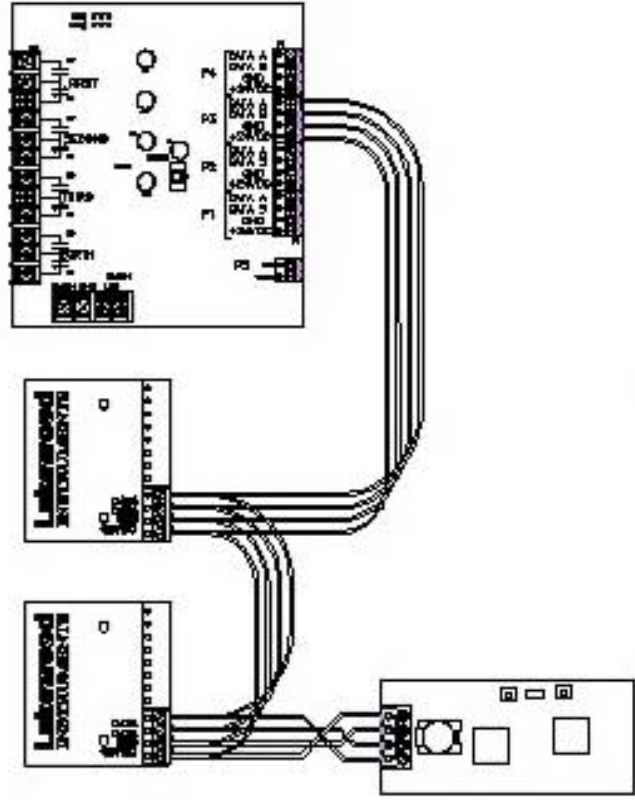

OR

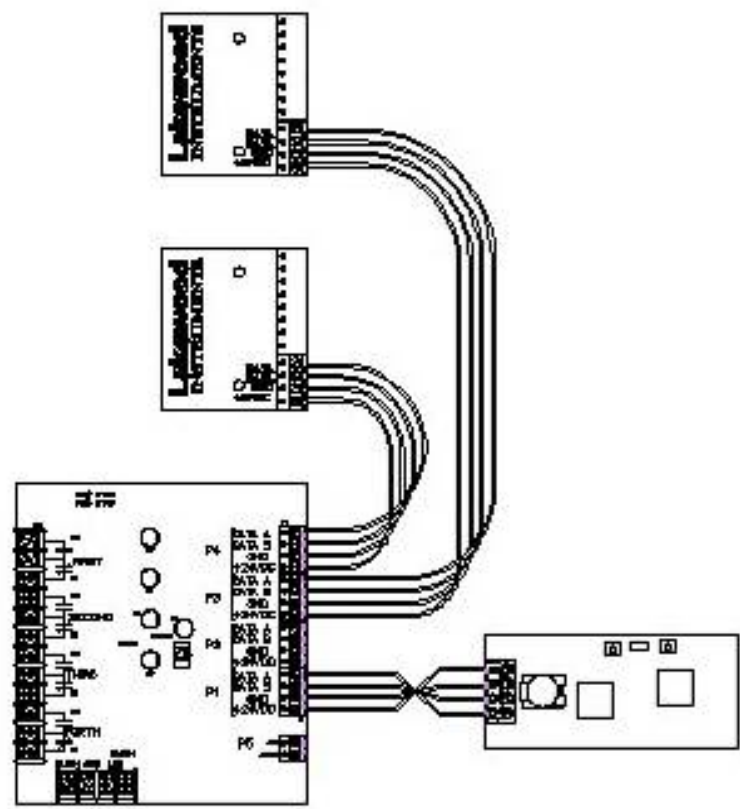

<b>Labwood INSTRUMENTS</b>		<b>Labwood INSTRUMENTS</b>	
TITLE: INSTALLATION DRAWING NIN OPTION		ORDER NO. 1187805-1a	
DATE: 5/3/87		REV: A	
BY: END		CHKD: END	
APP'D: END		DATE: END	
DO NOT SCALE		MAKE MOVE	



**For more information call toll free in the USA (800) 228-0839**

---

**Manufactured in the USA**

## Lakewood Instruments

*7838 North Faulkner Road, Milwaukee, WI 53224 USA*

*Phone (800) 228-0839 • Fax (414) 355-3508*

*<http://www.lakewoodinstruments.com>*